

Pumps & Motors

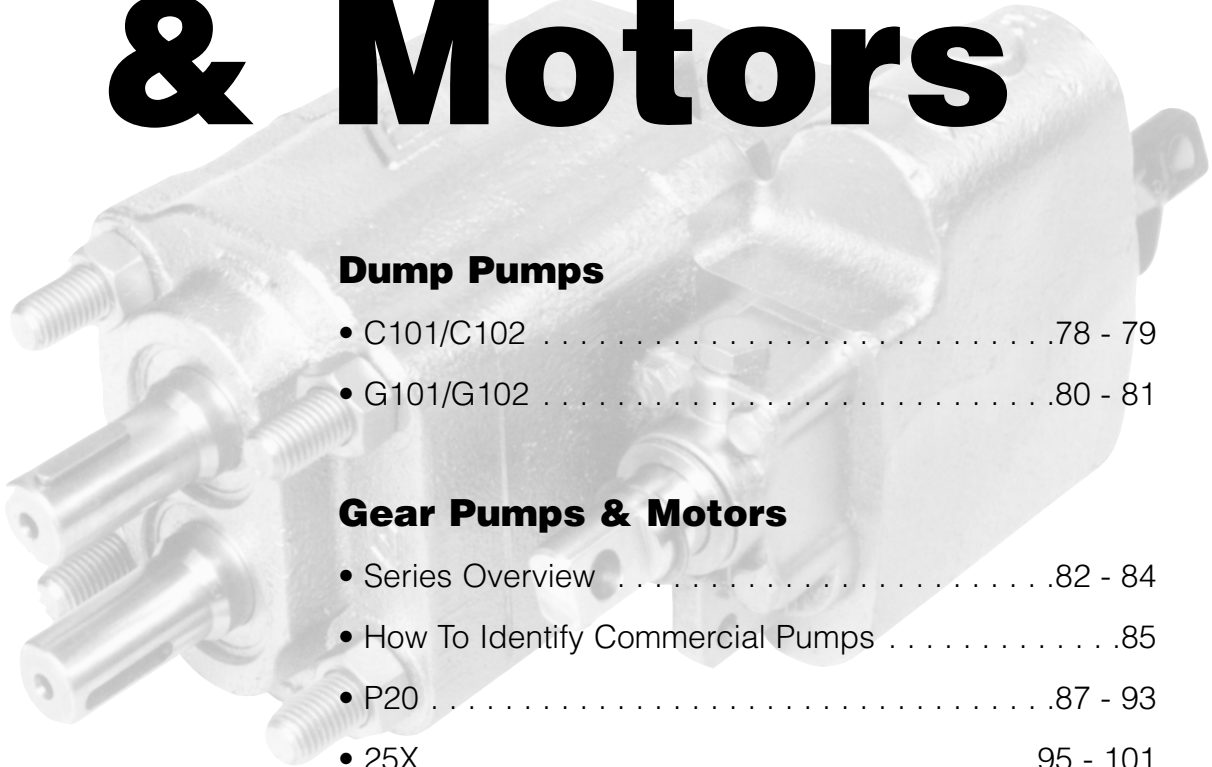

Dump Pumps

- C101/C10278 - 79
- G101/G10280 - 81

Gear Pumps & Motors

- Series Overview82 - 84
- How To Identify Commercial Pumps85
- P2087 - 93
- 25X95 - 101
- P30103 - 109
- P31111 - 116
- 37X117 - 122
- P50123 - 128
- P51129 - 134
- P75135 - 140
- P76141 - 146
- 330/350/365147 - 154

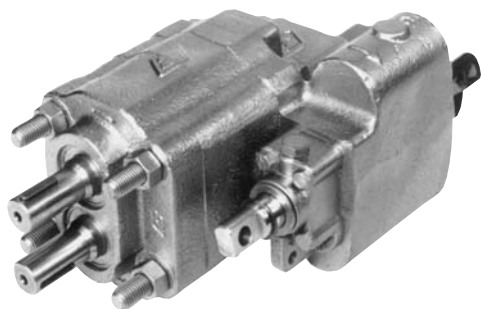

Heavy-Duty Hydraulic Power for Dump Trucks and Trailers

- 39 and 48 gpm @ 1800 rpm
- Pressures to 2500 psi
- Speeds to 2400 rpm
- 2- and 3-line installations
- Choice of mountings
- Air shift kits available
- Relief valve protects pump and cylinder



Reliable Pumps

Commercial has been the dump body industries pump/valve combination of choice for over 30 years. They're built on our heavy-duty P30 and P50 pump frames.

Commercial's pumps feature one-piece drive shafts and gears made of hardened, alloy steel and supported on heavy-duty roller bearings. Pressure balanced thrust plates provide an effective seal for continuous high efficiency and add to the outstanding service life of the pump.

Relief Valve Protection

A patented internal relief valve protects both the pump and the cylinder circuit. With the 3-position valve in the raise position, the relief valve acts as a system relief to protect against overloading. In the hold position, it acts as a port relief protecting the cylinder from shock loads commonly encountered during loading.

In three-line hookup, oil passing over the relief valve is vented to tank. This allows for continuous or intermittent operation. A 2-line hookup is used for intermittent operation only.

Commercial's pump/valves are rated for pressures to 2500 psi and are available in 9.5 gpm to 62 gpm (at 1800 rpm) models. Twin drive shafts permit them to be driven in either direction. The valve spools can be operated with a lever/cable or an air shift. Relief valves are factory set at 2000 psi.

Performance Data

Maximum speed is 2400 rpm. Operating pressures above 2000 psi are subject to the approval of our product support group. Performance data are the results of a series of tests of production units and are not necessarily representative of any one unit. Oil reservoir temperature was 120° F, viscosity of 150SUS at 100° F. Requests for more specific information should be directed to our component sales representatives.

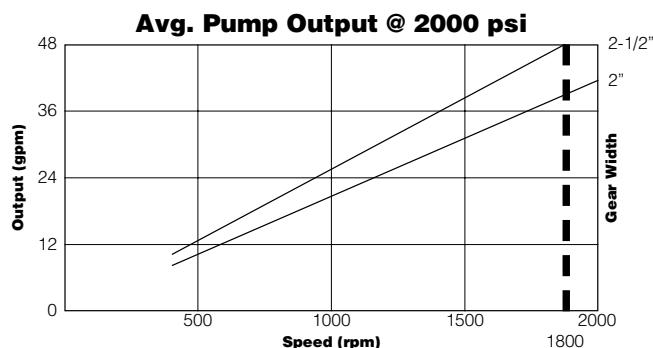

C101/C102 Parts break down list can be found on page 79

Seal Kit for C101 - CM-HC101
Seal Kit for C102 - CM-HC102

C101/C102 Parts Breakdown Typical Parts

Item	Description	Part No.	Req.	Item	Description	Part No.	Req.	Item	Description	Part No.	Req.
A	Shaft End Cover	313-5033-435	1	F	Ring Seal	391-2585-009	2	J	Pocket Seal	391-2882-050	12
B	Snap Ring	391-2686-065	1	G	Roller Bearing	391-0381-905	4	K	Stud	391-1425-110	4
C	Seal Retainer	391-3383-087	1	H	Thrust Plate	391-2185-912	2	L	Hex Nut	391-1451-076	6
D	Lip Seal	391-2883-115	1	I	Gear Set 2"	313-2920-230	1	M	Port End Cover		1
E	Check Assembly	393-3681-001	2		2 1/2"	313-2925-230	1	N	Valve Spool		1

C102 Shaft End Parts List replaces items 1 thru 11, 16 and 28 shown below.

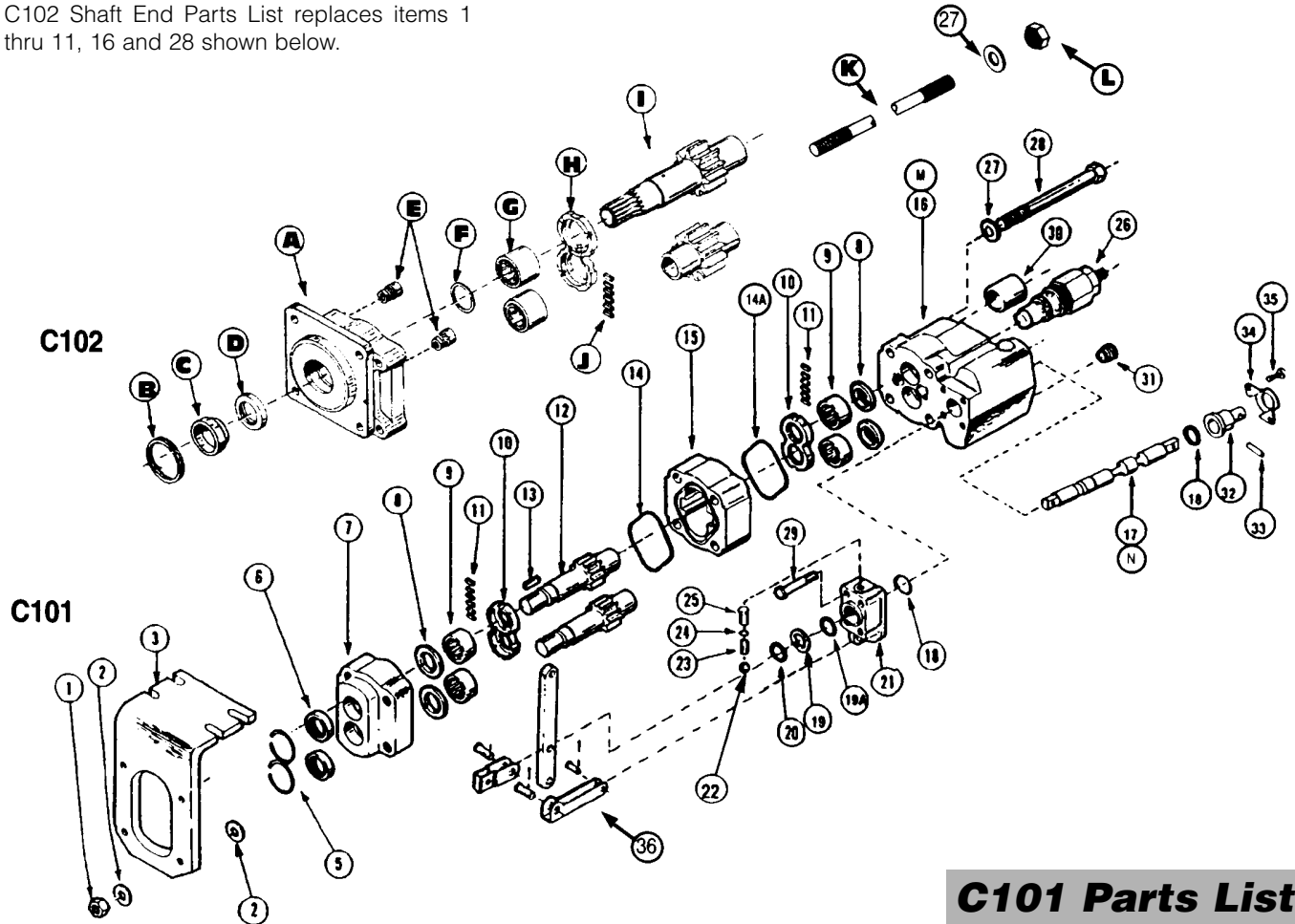

C101 Parts List

Item	Description	Part No.	Req.	Item	Description	Part No.	Req.	Item	Description	Part No.	Req.
1	Hex Nut	391-1451-076	4	15	Gear 2"	314-8020-100	1	27	Washer	391-3784-029	4
2	Washer	391-3784-028	8		Housing 2 1/2"	314-8025-100	1	28	Cap Screw 2"	391-1401-111	4
3	Bracket (optional)	314-0100-005	1	16*	Port End Cover		1		2 1/2"	391-1401-110	4
5	Snap Ring	391-2681-493	2	17*	Valve Spool		1	29	Cap Screw	391-1401-082	4
6	Lip Seal	391-2883-096	2	18	"O" Ring	391-2881-103	2	30	Sleeve (optional)	391-3283-052	1
7	Shaft End Cover	314-5039-201	1	19A	Wiper Ring	391-2883-147	1	31	Pipe Plug - 1" NPT	391-2282-006	1
8	Ring Seal	391-2585-009	4	19	Retainer Ring	391-3782-126	1	32	Spool End Cap	391-1881-073	1
9	Roller Bearing	391-0381-905	4	20	Snap Ring	391-2688-003	1	33	Spiral Pin	391-2085-009	1
10	Thrust Plate	391-2185-912	2	21	Detent Cap	314-0100-003	1	34	Bracket	391-0981-010	1
11	Pocket Seals	391-2882-050	12	22	Detent Ball	391-0282-009	1	35	Socket Hd. Cap Screw	391-1402-063	2
12	Gear Set 2"	314-2920-640	1	23	Detent Spring	391-3581-383	1				
	2 1/2"	314-2925-640	1	24	Lock Washer	391-3788-002	1				
13	Shaft Key	391-1781-021	1	25	Detent Retainer	391-2583-079	1				
14	Gasket Seal	391-2884-021	2	26	Relief Valve	355-9001-067	1				

* Items 16, 17 M and N are not serviceable parts.

Pump/Valve Combinations



- **9.5 to 29 gpm @ 1800 rpm**
- **Pressures to 2500 psi**
- **Speeds to 2400 rpm**
- **2- and 3-line installations**
- **Choice of mountings**
- **Air shift kits available**
- **Relief valve protects pump and cylinder**

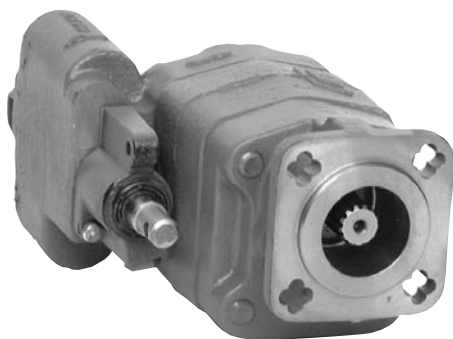

Reliable Pumps

Commercial's G101 pump/valves are a compact hydraulic power source for small dump trucks. They're based on Commercial's well proven P30 design. These heavy-duty units are rated for 2500 psi service at speeds up to 2400 rpm.

Pump output is controlled by a 3-way, 3-position valve built into the port end cover. The valve can be actuated from the truck's cab with a cable linkage or a remote air operator.

G101 Features:

- **Lightweight**
 - 31 lbs with 3/4" gears
 - 35 lbs with 1-1/2" gears
 - 38 lbs with 2" gears
- **Twin drive shafts make installation easy regardless of rotation direction**
- **2- or 3-line plumbing hookup**
- **Output @ 1800 rpm**
 - 9.5 gpm (3/4" gears)
 - 21 gpm (1-1/2" gears)
 - 29 gpm (2" gears)

Mounting

The G101 is mounted with a 2-bolt pad cast into the shaft end cover. The G102 direct PTO mount version is available with SAE-B 2- or 4-bolt flange mountings or a cloverleaf mount with 2.75" pilot diameter.

Drive Shafts

G101's have twin 1" SAE-BB keyed shafts that permit CW or CCW hookup without modifying the unit. G102's have a single SAE-B splined shaft. Please specify direction of rotation when ordering G102 models.

Relief Valve Protection

The G101's internal relief valve protects both the cylinder and the pump. With the valve in the raise position, it protects the system against overloading. In hold, it acts as a port relief to protect the cylinder from shock loads. The relief valve is factory set at 2000 psi.

Performance Data

Performance data shown are average results based on a series of laboratory tests of production units and are not representative of any one unit. Tests were run with the oil reservoir temperature was 120° F, viscosity of 150SUS at 100°F. Requests for more specific information should be directed to our component sales representatives.

Avg. Pump Output @ 2000 psi

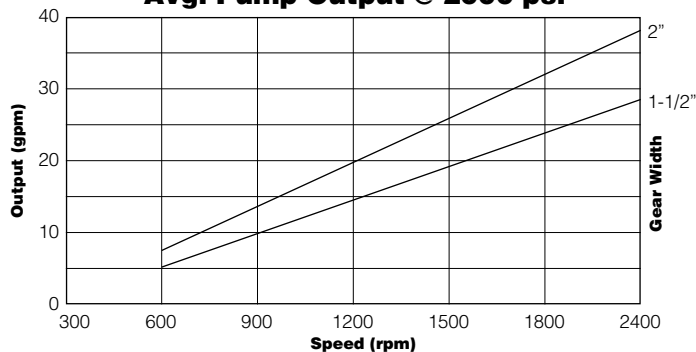

C101/C102 Parts break down list can be found on page 81

Seal Kit for G101 - CM-HG101
 Seal Kit for G102 - CM-HG102

G101/G102 Parts Breakdown Typical Parts List

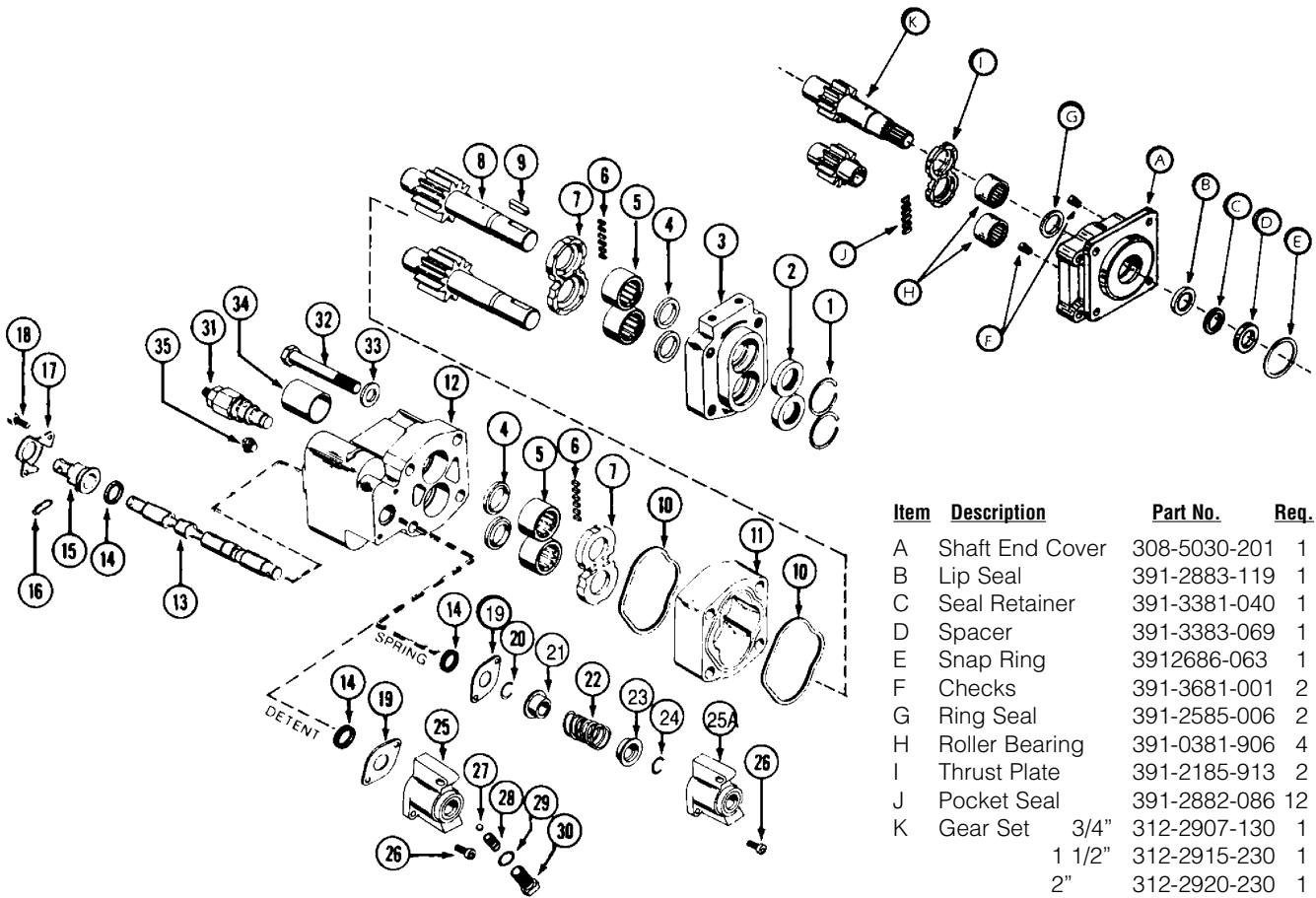

Item	Description	Part No.	Req.
A	Shaft End Cover	308-5030-201	1
B	Lip Seal	391-2883-119	1
C	Seal Retainer	391-3381-040	1
D	Spacer	391-3383-069	1
E	Snap Ring	3912686-063	1
F	Checks	391-3681-001	2
G	Ring Seal	391-2585-006	2
H	Roller Bearing	391-0381-906	4
I	Thrust Plate	391-2185-913	2
J	Pocket Seal	391-2882-086	12
K	Gear Set	3/4" 312-2907-130	1
		1 1/2" 312-2915-230	1
		2" 312-2920-230	1

G102 Shaft End Parts List replaces items 1 thru 8 in G101 Parts List below.

G101 Parts List

Item	Description	Part No.	Req.	Item	Description	Part No.	Req.	Item	Description	Part No.	Req.
1	Snap Ring	391-2681-487	2	12	Port End Cover		1	26	Cap Screw	391-1433-020	2
2	Lip Seal	391-2883-119	2	13	Spool		1	27	Detent Ball	391-0282-009	1
3	Shaft End Cover	308-5016-201	1	14	Quad Ring Seal	391-1985-014	2	28	Spring	391-3581-383	1
4	Ring Seal	391-2585-006	4	15	Spool End Cap	391-1881-072	1	29	Lock Washer	391-3788-002	1
5	Roller Bearing	391-0381-906	4	16	Spiral Pin	391-2085-009	1	30	Detent Retainer	391-2583-079	1
6	Pocket Seal	391-2882-086	12	17	Bracket	391-0981-007	1	31	Relief Valve	355-9001-197	1
7	Thrust Plate	391-2185-913	2	18	Skt Hd Cap Screw	391-1402-063	2	32	Cap Screw	3/4" 391-1401-395	4
8	Gear Set	3/4" 312-2907-842	1	19	Cover Plate	391-2183-124	1			1 1/2" 391-1401-381	4
		1 1/2" 312-2915-842	1	20	Retaining Ring	391-2681-485	1			2" 391-1401-382	4
		2" 312-2920-842	1	21	Spring Guide	391-1642-136	1	33	Washer	391-3782-146	4
9	Key	391-1781-021	1	22	Spring	391-3581-212	1	34	Sleeve (optional)	391-3283-052	1
10	Gasket Seal	391-2884-019	2	23	Spring Guide	39101642-137	1	35	Pipe Plug	391-2282-003	1
11	Gear	3/4" 308-8007-901	1	24	Retaining Ring	391-2681-486	1				
	Housing	1 1/2" 308-8015-901	1	25A	End Cap	308-4000-100	1				
		2" 308-8020-901	1	25	End Cap	308-4000-102	1				

Series P20

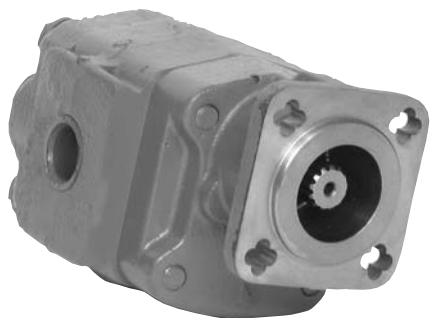

- 6 TO 33 gpm @ 2000 rpm
- Pressures to 2000 psi
- Speeds to 2000 rpm
- Choice of mountings

Flow (GPM) @ Pump RPM

Speed rpm	Gear Width (inches)				
	1	1-1/4	1-1/2	1-3/4	2
900	6.5	8	10	12	13.5
1200	9	11.5	14	16	18.5
1500	11.5	14.5	17.5	20.5	23.5
1800	14	18	21.5	25	29
2100	16.5	21	25	29.5	34
2400	19	24	29	34	39

Series 25X



- 8.5 TO 53 gpm @ 2000 rpm
- Pressures to 2000 psi
- Speeds to 2000 rpm
- Choice of mountings

Flow (GPM) @ Pump RPM

Speed rpm	Gear Width (inches)						
	1	1-1/4	1-1/2	1-3/4	2	2-1/4	2-1/2
900	8.5	10.5	13	15	17.5	20	22
1200	12	15	18	21	24	27	30
1500	15	19	23	27	31	35	39
1800	18	23	27.5	32.5	37.5	42	47
2100	21.5	27	32.5	38.5	44	49.5	55
2400	25	31	37	44	51	57	63.5

Series P30, P31

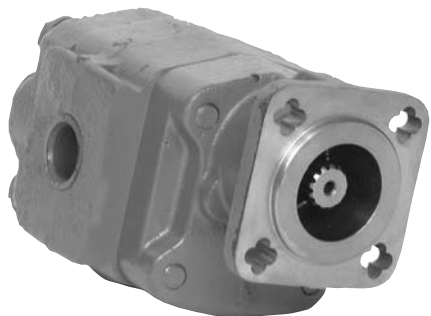

- 6 TO 33 gpm @ 2000 rpm
- Pressures to 2000 psi
- Speeds to 2000 rpm
- Choice of mountings

Flow (GPM) @ Pump RPM

Speed rpm	Gear Width (inches)				
	1	1-1/4	1-1/2	1-3/4	2
900	6.5	8	10	12	13.5
1200	9	11.5	14	16	18.5
1500	11.5	14.5	17.5	20.5	23.5
1800	14	18	21.5	25	29
2100	16.5	21	25	29.5	34
2400	19	24	29	34	39

Series 37X

- 6 TO 75 gpm @ 2000 rpm
- Pressures to 2000 psi
- Speeds to 2000 rpm
- Choice of mountings



Flow (GPM) @ Pump RPM

Speed rpm	Gear Width (inches)							
	1	1-1/4	1-1/2	1-3/4	2	2-1/4	2-1/2	3
600	4.5	6.5	8.5	10.5	12.5	14	16.5	20
1200	12.5	16.5	20	24	28	31.5	35.5	43
1800	20	26	31.5	37.5	43.5	49.5	55	66.5
2100	24	31	37.5	44.5	51	58	64.5	78
2400	28	36	43.5	51	59	67	74.5	90

Series P50, P51

- 6 TO 53 gpm @ 2000 rpm
- Pressures to 2000 psi
- Speeds to 2000 rpm
- Choice of mountings

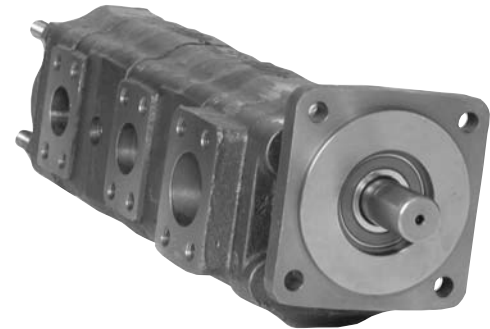

Flow (GPM) @ Pump RPM

Speed rpm	Gear Width (inches)						
	1	1-1/4	1-1/2	1-3/4	2	2-1/4	2-1/2
900	8.5	10.5	13	15	17.5	20	22
1200	12	15	18	21	24	27	30
1500	15	19	23	27	31	35	39
1800	18	23	27.5	32.5	37.5	42	47
2100	21.5	27	32.5	38.5	44	49.5	55
2400	25	31	37	44	51	57	63.5

Series P75, P76

- 6 TO 100 gpm @ 2000 rpm
- Pressures to 2000 psi
- Speeds to 2000 rpm
- Choice of mountings

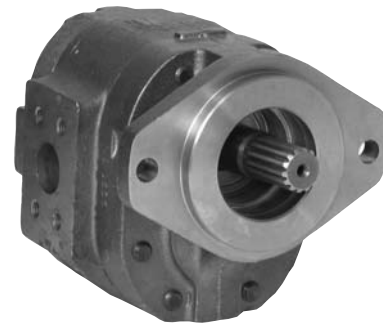

Flow (GPM) @ Pump RPM

Speed rpm	Gear Width (inches)								
	1	1-1/4	1-1/2	1-3/4	2	2-1/4	2-1/2	2-3/4	3
600	6	9	11.5	13.5	16.6	18.5	21	23	26
1200	17	22	27	32	37.5	42	48	52.5	58
1500	22	29	35.5	41.5	48	54.5	61	67	74
1800	27.5	35.5	43.5	51	59	66	74	81.5	90
2100	33	42	51.5	60	69.5	78	87	96.5	106
2400	38	49	59.5	70	80	90	101	111	122

Series 330, 350, 365



- 6 TO 78 gpm @ 2000 rpm
- Pressures to 3500 psi
- Speeds to 3000 rpm
- Choice of mountings

Series 330



Pump Speed rpm	Avg. Output (gpm) @ 3500 psi Gear Width (inches)				
	1	1-1/4	1-1/2	1-3/4	2
900	6.0	8.0	10.0	12.0	13.5
1200	8.5	11.5	14.0	16.0	18.5
1500	11.0	14.5	17.5	20.5	23.5
2100	16.5	21.0	25.0	29.5	34.0

2" data at 3000 psi

Series 350



Pump Speed rpm	Avg. Output (gpm) @ 3500 psi Gear Width (inches)						
	1	1-1/4	1-1/2	1-3/4	2	2-1/4	2-1/2
900	8.0	10.5	13.0	15.0	17.5	20.0	22.0
1200	11.5	15.0	18.0	21.0	24.0	27.0	30.0
1500	14.5	19.0	23.0	27.0	31.0	35.0	39.0
2100	21.0	27.0	32.5	38.5	44.0	49.5	55.0

2-1/2" data at 2500 psi
2" data at 3000 psi

Series 365



Pump Speed rpm	Avg. Output (gpm) @ 3500 psi Gear Width (inches)						
	1	1-1/4	1-1/2	1-3/4	2	2-1/4	2-1/2
900	10.5	13.5	15.0	17.0	20.5	27.5	31.0
1200	15.5	20.0	24.5	29.0	33.5	38.0	43.0
1500	20.0	25.5	31.0	37.5	43.0	49.0	55.0
2100	29.0	37.5	45.5	54.0	62.0	70.0	78.0

2-1/2" data at 3000 psi

By the Shape and Size of the Port End Cover

1. Look at the Unit from the Port End, see which example it matches the closest. Include the Shape, Size, and **most importantly** the Bolt Pattern.
2. Measure the overall width of the Unit, then match the width to the chart beside the Port End you chose in step #1.
3. If there is not a "See Also" block on the chart you used, then you've identified the Unit. Otherwise move to step #4.
4. A Numbered Note marker will direct you to the next step or steps.

PORT END VIEW

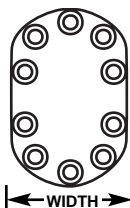

Series	"D"
Width	4.50

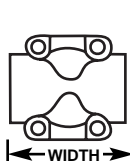

Series	315	330	350	365
Side Ported Width	4.25	6.68	7.12	7.38
Unported Width	4.00	4.81	5.75	6.25

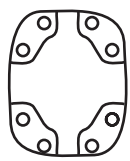
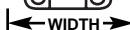

Series	37X	75 / 76	125
Width	5.12	6.13	7.00
See Also		②	

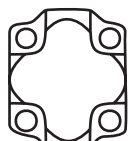

Series	15H	25X	20	30/31	50/51
Width	4.38	4.94	4.50	4.81	4.94
See Also		①		②	①②

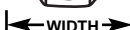

① SHAFT END VIEW

Look at the Unit from the Shaft End, compare it to the views below. Select the Shaft type on your Unit.

SERIES 31/51



NO RETAINER/
OUTBOARD BEARINGS

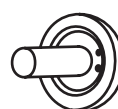

W/SNAP RING
(SEE NOTE BELOW)

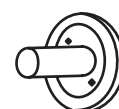

SCREW IN
RETAINER

25X/37X

② DISASSEMBLE UNIT

This step requires the Port End Cover of the Unit to be removed & inspected for Dowel Pins. This is the only way to tell the difference between some Series.

Series 31/51/76: Assembled with Dowel Pins.

**Call Our Component Sales Team
If You Need More Assistance.**

Identifying Commercial Gear Width Compared to Pump or Motor Housing Width

1. Measure the gear housing width (See Illustration).
2. Then match the housing width to the series of pump/motor you are using.
3. Check the chart for the nearest measurement (rounding up) to give you the proper gear width.

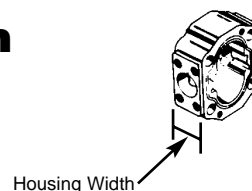

P20 Series	Gear Width	0.50"	0.75"	1.00"	1.25"	1.50"	1.75"	2.00"					
	Housing Width	1.25"	1.50"	1.75"	2.00"	2.25"	2.50"	2.75"					
P25X Series	Gear Width	0.50"	0.75"	1.00"	1.25"	1.50"	1.75"	2.00"	2.25"	2.50"			
	Housing Width	1.25"	1.50"	1.75"	2.00"	2.25"	2.50"	2.75"	3.00"	3.25"			
P30/P31 Series	Gear Width	0.50"	0.75"	1.00"	1.25"	1.50"	1.75"	2.00"					
	Housing Width	1.25"	1.50"	1.75"	2.00"	2.25"	2.50"	2.75"					
P37X	Gear Width	0.25"	0.50"	0.75"	1.00"	1.25"	1.50"	1.75"	2.00"	2.25"	2.50"	3.00"	
	Housing Width	1.25"	1.50"	1.75"	2.00"	2.25"	2.50"	2.75"	3.00"	3.25"	3.50"	4.00"	
P50/P51 Series	Gear Width	0.50"	0.75"	1.00"	1.25"	1.50"	1.75"	2.00"	2.25"	2.50"			
	Housing Width	1.25"	1.50"	1.75"	2.00"	2.25"	2.50"	2.75"	3.00"	3.25"			

P75/P76	Gear Width	0.75"	1.00"	1.25"	1.50"	1.75"	2.00"	2.25"	2.50"	2.75"	3.00"			
	Housing Width	1.75"	2.00"	2.25"	2.50"	2.75"	3.00"	3.25"	3.50"	3.75"	4.00"			
P330 Series	Gear Width	0.50"	0.75"	1.25"	1.50"	1.75"	2.00"							
	Housing Width	1.00"	1.25"	1.75"	2.00"	2.25"	2.50"							
P350 Series	Gear Width	0.50"	0.75"	1.25"	1.50"	1.75"	2.00"	2.25"	2.50"					
	Housing Width	1.00"	1.25"	1.75"	2.00"	2.25"	2.50"	2.75"	3.00"					
P365 Series	Gear Width	0.75"	1.25"	1.50"	1.75"	2.00"	2.25"	2.50"						
	Housing Width	1.25"	1.75"	2.00"	2.25"	2.50"	2.75"	3.00"						



P20

General Information

Commercial's P20 gear pumps and motors are an ideal power for the truck industry. With 1/2" gears, it measures only 6" from mounting flange to the port end cover and weighs only 25 lbs.

The P20 can produce flows up to 2.96 cir @ 300 psi; output to 3.94 cir up to 2500 psi. Maximum speed is 2400 rpm. Motors and pumps can be bi-rotational.

A variety of drive shafts and mounting styles are offered to meet your needs. Standard features include rigid, one-piece drive shaft and gears and pressure balanced thrust plates which assure top efficiency.

Performance Data

Performance data shown are the average results based on a series of laboratory tests of production units and are not necessarily representative of any one unit. Tests were run with the oil reservoir temperature at 120°F. Requests for more specific data should be directed to our sales representatives.

Performance data for pumps and motors having other gear widths can be approximated by multiplying values in tables below by actual gear width.

Pump Speed rpm	Avg. Output (gpm) @ 2000 psi Gear Width (inches)				
	1	1-1/4	1-1/2	1-3/4	2
900	6.5	8.0	10.0	12.0	13.5
1200	9.0	11.5	14.0	16.0	18.5
1500	11.5	14.5	17.5	20.5	23.5
2100	16.5	21.0	25.0	29.0	34.0

Motor Speed rpm	Avg. Input/Output (gpm) @ 2000 psi					
	1" gear		1-1/2" gear		2" gear	
rpm	gpm	hp	gpm	hp	gpm	hp
800	9.0	7.0	13.0	11.0	17.0	14.5
1200	13.0	10.5	18.0	16.5	23.5	22.0
1600	16.4	14.0	23.0	22.0	30.5	29.0
2000	19.5	17.5	28.0	27.0	37.0	36.0

How To Specify and Code

This catalog contains codes for our most popular models. Complete codes for all configurations are readily available upon request.

Single Units

Full assembly codes for single units combine shaft end cover, port end cover, gear housing and drive shaft codes. They are preceded by the letter P or M for pump or motor — and by 20 to designate the series and model. An example of an assembly code follows:

M20 SINGLE MOTOR

Assembly Code: **M 20A 942 BE YF15-30**

- MotorM
- Series20
- ModelA
- 1. Shaft End Cover942
- 2. Port End CoverBE
- 3. Gear HousingYF15
- 4. Drive Shaft30

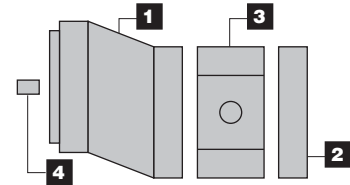

Multiple Units

Coding is the same as single units except that codes for added components must be included. Each gear unit added also requires code for a bearing carrier, the additional gear housing and connecting shaft. An example of an assembly code for a two-section Series 20 pump follows:

P20 MULTIPLE PUMP

Assembly Code: **P 20B 278 BY OM20-43 D UG10-1**

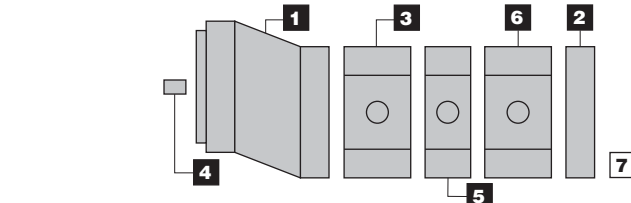

- PumpP
- Series30
- ModelB
- 1. Shaft End Cover278
- 2. Port End CoverBY
- 3. Gear HousingOM20
- 4. Drive Shaft43
- 5. Bearing CoverD
- 6. Gear HousingUG10
- 7. Connecting Shaft1

Variations

Series 20 units are available with gear sections ranging from 1/2" to 2" in 1/4" increments which provide displacements from .985 to 3.94 cu. in. per revolution. Two or more gear sections can be assembled on one drive shaft to provide larger flows, supply other circuits or make smoother, more powerful motors.

When specifying multiple units you must consider the drive shaft's strength. This is called a PL factor in which P = operating pressure and L = sum of gear widths. The recommended PL factors for various Series 20 shafts are shown with the shaft codes and are offered as a guide to shaft selection. A PL of 8000 means a maximum of 4" of gear can be operated at 2000 psi (2000 psi X 4" = 8000) without overloading the shaft. The gear widths can be divided many ways, eg. (2"-1"-1", 1"-1"-1"-1", 1-1/2"-1-1/2"-1/2") to provide the output you need for several circuits. This pump needs a drive shaft with a PL factor of 4500 or more to operate successfully.

P20 Parts Breakdown Typical Parts List

For Series P20 Seal Kits and Repair Parts, See Pages 475 - 477

Note:

This page shows the typical arrangement of a 2-section unit. It may not be pictorially correct and is not to scale.

Plug 5 in position B gives clockwise rotation.

Plug 5 in position A gives counter-clockwise rotation.

Check valves in both positions give bi-directional rotation.

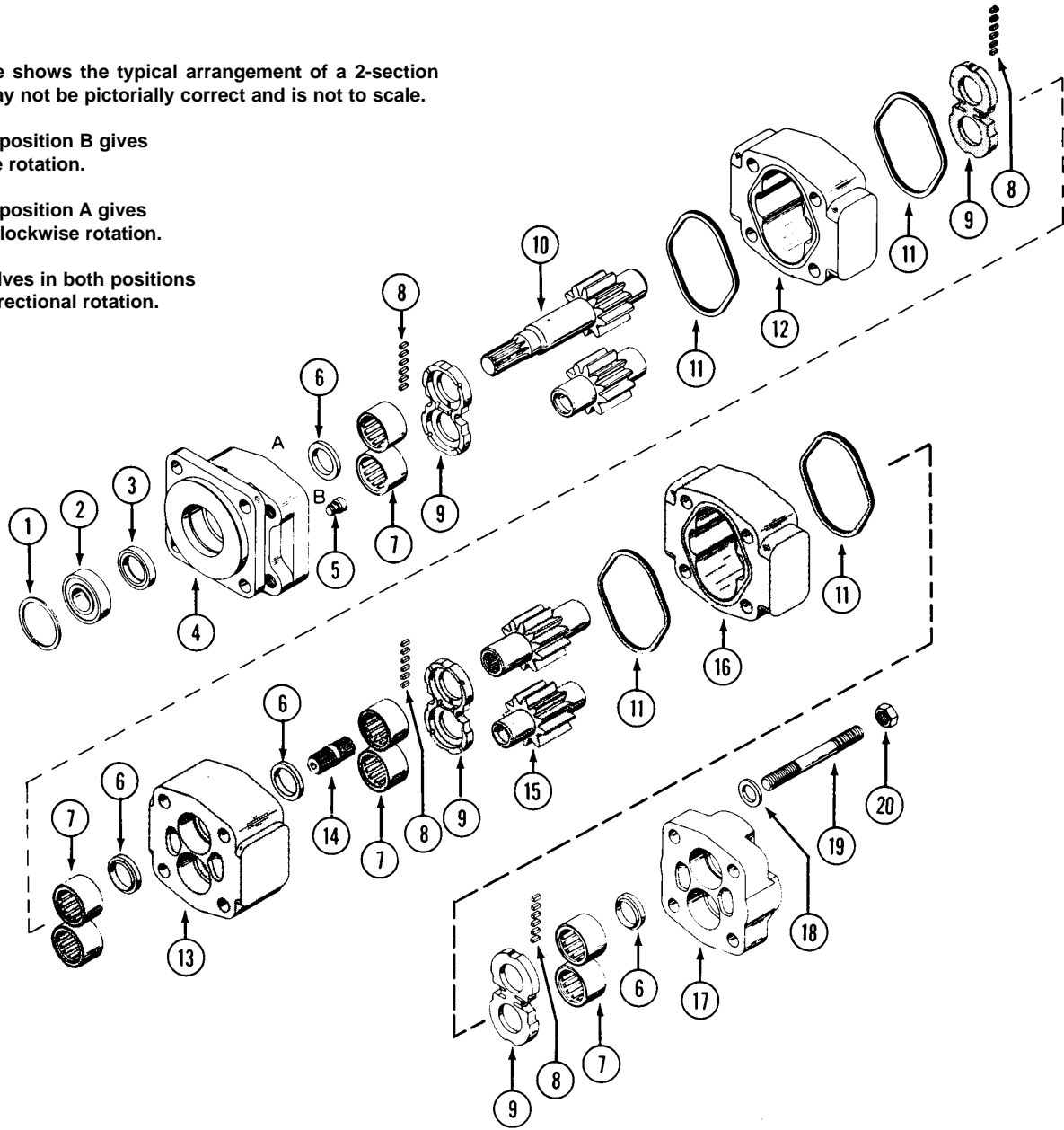

Item	Description	Part Number	Item	Description	Part Number
1	Snap Ring	CM-391-2686-063	11	Gasket Seals	580-239
2	Outboard Bearing	CM-391-0381-040	12	Gear Housing	See Option List
3	Seal	CM-391-2883-058	13	Bearing Carrier	See Option List
4	Shaft End Cover	See Option List	14	Connecting Shaft	See Option List
5	Check Assemblies or Plug	CM-391-3681-001	15	Matched Gear Set	See Option List
6	Ring Seals	CM-391-2585-006	16	Gear Housing	See Option List
7	Roller Bearings	CM-391-0381-906	17	Port End Cover	See Option List
8	Pocket Seals		18	Washers	
9	Thrust Plates	CM-391-2185-913	19	Studs or Cap Screws	
10	Integral Drive Shaft and Gear Set	See Option List	20	Nuts	

1 & 2 Shaft & Port End Covers

P20 SHAFT END COVERS

Description	Type	Outboard Bearing	PUMPS			MOTORS	
			CW	CCW	Double	1/4" NPT DRAIN	1/4" BSPP DRAIN
Round Flange - 6 Bolt	1	Without	105	205	305	905	1905
		With	405	505	605	805	1805
SAE B - 4 Bolt	1	Without	142	242	342	942	1942
		With	442	542	642	842	1842
4 Bolt Cloverleaf PTO Mount	2	Without	127	227	327	—	—
SAE A - 2 Bolt	1	Without	194	294	394	994	1994
		With	494	594	694	894	1894
SAE B - 2 Bolt	1	Without	197	297	397	997	1997
		With	497	597	697	897	1897
	2	Without	196*	296*	396*	N/A	N/A
Piggy Back Shaft End Cover	50-30	Without	191	291	391	N/A	N/A
	30-30	Without	191	291	391	N/A	N/A
	75-30	Without	192	292	392	N/A	N/A
Pad Mounting	1	Without	110	210	310	910	N/A
		With	410	510	610	910	N/A

* Available for special application upon request.
NOT A STOCK ITEM

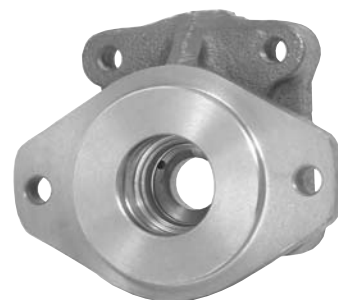

P20 PORT END COVERS

Description	Single Pumps	Multiple Pumps		Porting	
		w/Reg Studs	w/2 Ext Studs	LH	RH
No Ports	BE	BI	BY	—	—
NPT Ports	KE*	KI	KY	3/4	—
	LE*	LI	LY	—	3/4
	ME*	MI	MY	3/4	3/4
ODT Ports	CE*	CI	CY	3/4	—
	DE*	DI	DY	—	3/4
	FE*	FI	FY	3/4	3/4
	GE*	GI	GY	1	3/4
	HE	HI	HY	3/4	1
	JE*	JI*	JY*	1	1

Priority Outlet see P1B-H2 for description of codes
*Available for special application upon request.
NOT A STOCK ITEM.



4 Drive Shafts



P20 DRIVE SHAFTS

Shaft Description	Code		
	Type 1	Type 2	
SAE B - Straight Keyed .875" Diameter - 1/4" X 1" Key	30	—	
Standard - Straight Keyed .9998" Diameter - 1/4" X 1 1/4" Key	43	—	
SAE B - 13 Tooth Spline .873 Major Diameter	25	65*	
Standard - 6 Tooth Spline .997" Major Diameter	68*	—	
SAE A - 9 Tooth Spline .623" Major Diameter	95	—	
Connecting Shaft - Multiple Units	1	1	
Connecting Shaft - Piggyback Pump	P30 to P30	14	—
	P50 to P30	22	—
	P75 to P30	23	—

* Available for special application upon request. Not a stock item.

P20 DRIVE SHAFT CODES

GEAR WIDTH	1-14-22-23	25	30	43	65*	68*	95
1/2	•						
3/4	•	•	•	•			
1	•	•	•	•	•	•	•
1 1/4	•	•	•	•	•	•	•
1 1/2	•	•	•	•	•	•	
1 3/4	•	•	•	•	•	•	
2	•	•	•	•	•	•	

3 & 6 Gear Housings



P20 GEAR HOUSINGS - NPT PORTS

Porting		1/2	3/4	1	1 1/4	1 1/2	1 3/4	2
LH	RH							
—	—	AB05	AB07	AB10	AB12	AB15	AB17	AB20
1/2	—		IL07	IL10				
—	1/2		IM07	IM10				
1/2	1/2		IR07					
3/4	—			IC10	IC12	IC15		
—	3/4			ID10	ID12	ID15		
3/4	3/4			IF10	IF12	IF15	IF17	IF20
3/4	1‡			IG10‡	IG12			
1‡	3/4			IJ10	IJ12	IJ15	IJ17	
1	—				YC12	YC15	YC17	
—	1				YD12	YD15	YD17	
1	1				YF12	YF15	YF17	YF20
1	1 1/4‡					YG15‡	YG17	YG20
1 1/4‡	1					YJ15‡	YJ17	YJ20
1 1/4	1 1/4							YL20
1 1/4‡	—					IA15‡	IA17	IA20
—	1 1/4‡					IB15‡	IB17	IB20
1 1/4	1 1/2‡							YM20‡
1 1/2‡	1 1/4							YP20‡
1 1/2‡	—							YA20‡
—	1 1/2‡							YB20‡

‡ Low pressure only

3 & 6 Gear Housing



P20 GEAR HOUSINGS - SAE SPLIT FLANGE PORTS

Porting		1/2	3/4	1	1 1/4	1 1/2	1 3/4	2
LH	RH							
—	—	AB05	AB07	AB10	AB12	AB15	AB17	AB20
3/4	—			UC10	UC12			
—	3/4			UD10	UD12	UD15		
3/4	3/4			UF10				
3/4	1			UG10	UG12			UG20
3/4	1 1/4				UH12			
1	3/4			UJ10	UJ12	UJ15	UJ17	UJ20
1 1/4	3/4				UK12			
1	—				OC12	OC15	OC17	
—	1				OD12	OD15	OD17	OD20
1	1			OF10	OF12	OF15	OF17	OF20
1	1 1/4‡				OG12‡	OG15	OG17	OG20
1 1/4‡	1				OJ12‡	OJ15	OJ17	OJ20
1	1 1/2‡						OH17‡	OH20
1 1/2‡	1						OK17‡	OK20
1 1/4‡	—				OA12‡	OA15	OA17	OA20
—	1 1/4‡				OB12‡	OB15	OB17	OB20
1 1/4	1 1/4					OL15	OL17	OL20
1 1/4	1 1/2‡						OM17‡	OM20
1 1/2‡	1 1/4						OP17‡	OP20
1 1/2‡	—						OE17‡	OE20
—	1 1/2‡						OU17‡	OU20

‡ Low Pressure Only







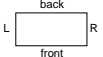

P20 GEAR HOUSINGS - SAE STRAIGHT THREAD PORTS

Porting		1/2	3/4	1	1 1/4	1 1/2	1 3/4	2
LH	RH							
—	—	AB05	AB07	AB10	AB12	AB15	AB17	AB20
3/4	—			EC10	EC12	EC15		
—	3/4			ED10	ED12	ED15		
3/4	3/4			EF10	EF12	EF15	EF17	EF20
3/4	1‡			EG10‡	EG12‡	EG15	EG17	
3/4	1 1/4‡					EH15‡	EH17‡	
3/4	1 1/2‡							IN20‡
1‡	3/4			EJ10‡	EJ12‡	EJ15	EJ17	EJ20
1 1/4‡	3/4					EL15‡	EK17‡	
1 1/2‡	3/4							IP20‡
7/8	—				EZ12			
7/8	1‡			EL10‡	EL12‡			
1‡	7/8			EM10‡	EM12‡			
1‡	—			AC10‡	AC12	AC15	AC17	AC20
—	1‡			AD10‡	AD12	AD15	AD17	AD20
1	1					AF15	AF17	AF20
1	1 1/4‡					AG15‡	AG17‡	AG20
1	1 1/2‡						AH17‡	AH20‡
1 1/4‡	1					AJ15‡	AJ17‡	AJ20
1 1/2‡	1						AK17‡	AK20‡
1 1/4‡	—					AA15‡	AA17‡	
—	1 1/4‡					AO15‡	AO17‡	
1 1/4	1 1/4						AL17	AL20
1 1/4	1 1/2‡						AM17‡	AM20‡
1 1/2‡	1 1/4						AP17‡	AP20‡
1 1/2‡	—						AE17‡	AE20
—	1 1/2‡						AU17‡	AU20

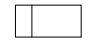
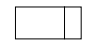
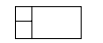
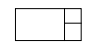
‡Low pressure only

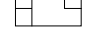
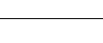
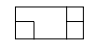
5 Bearing Carriers

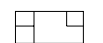

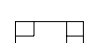



P20 BEARING CARRIERS (PUMPS ONLY)

	Porting		NPT Parts Code	SAE Split Flange Code	SAE Straight Thread Code
	LH	RH			
	—	—	B Motor Only	—	—
	—	—	C	—	—
	—	—	D	—	—
	1 1 1/4 1 1/2	—	TB VB —	LB MN NB	CB DB FB
	—	1 1 1/4 1 1/2	BT BV —	BL BM BN	BC BD BF
	Inlet — 1 1 1/4 1 1/4 1 1/2 1 1/2	Outlet 3/4 3/4 1 1 3/4	— TX VX VZ — —	BR LR MR MS NS NR	— CJ DJ DK FK FJ
	Outlet 3/4 3/4 1 1 3/4	Inlet 1 1 1/4 1 1/2 1 1/2	JT JV KV — —	XL XM ZM ZN XN	RC RD SD SF RF
	Inlet 1 1 1/4 1 1/4 1 1/2 1 1/2	Outlet 3/4 3/4 1 — —	TJ VJ VK — —	LX MX MZ NZ NX	CR DR DS FS FR
	Outlet 3/4 3/4 1 3/4 3/4	Inlet 1 1 1/4 1 1/2 —	XT XV ZV — —	RL RM SM SN RN RB	JC JD KD KF JF JP
	Inlet 1	Outlet 3/4	ZX	SR	KJ
	Outlet 3/4	Inlet 1	XZ	RS	JK
	Inlet 1 3/4	Outlet 3/4 1	ZS SZ	RZ ZR	KX XK
	Motors Only 1 1 1/4 1 1/2	1 1 1/4 1 1/2	TT VV —	LL MM NN	CC BB FF

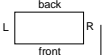
Pump applications must be approved by Technical Service.

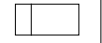
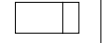
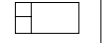
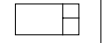
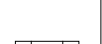
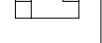
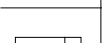
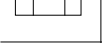
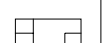

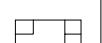
P20 BEARING CARRIERS (PUMPS ONLY)

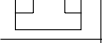
	Porting		BSPP Ports Code	Metric Split Flange Code	Porting		Metric Straight Thread Code
	LH	RH			LH	RH	
	—	—	B*	B*	—	—	B*
	—	—	C	C	—	—	C
	—	—	D	D	—	—	D
	1 1 1/4 1 1/2	—	CX DX	CH DH FH	M33 X 2 M42 X 2 M48 X 2	— — —	CL DL FL
	—	1 1 1/4 1 1/2	XC XD	HC HD HF	— — —	M33 X 2 M42 X 2 M48 X 2	LC LD LF
	Inlet — 1 1 1/4 1 1/2 1 1/2	Outlet 3/4 3/4 3/4 1 3/4	— CT DT DV	PW CW DW DC FC FW	Inlet — M33 X 2 M42 X 2 M42 X 2 M48 X 2 M48 X 2	Outlet — M26 X 1.5 M26 X 1.5 M33 X 2 M33 X 2 M33 X 2 M26 X 1.5	— CZ DZ DN FN FZ
	Outlet 3/4 3/4 1 1 1	Inlet 1 1 1/4 1 1/4 1 1/2	MG MH NH	QG QH SH SW	Outlet M26 X 1.5 M26 X 1.5 M33 X 2 M33 X 2	Inlet M33 X 2 M42 X 2 M42 X 2 M48 X 2	TG TH VH VW
	Inlet 1 1 1/4 1 1/4 1 1/2	Outlet 3/4 3/4 1	GM HM HN	GQ HQ HS WS	Inlet M33 X 2 M42 X 2 M42 X 2 M48 X 2	Outlet M26 X 1.5 M26 X 1.5 M33 X 2 M33 X 2	GT HT HV VW
	Outlet 3/4 3/4 3/4 1 1 3/4	Inlet — 1 1 1/4 1 1/4 1 1/2 1 1/2	— TC TD VD	WP WC WD CD CF WF	Outlet — M26 X 1.5 M26 X 1.5 M33 X 2 M33 X 2 M33 X 2 M26 X 1.5	Inlet M33 X 2 M42 X 2 M42 X 2 M48 X 2 M48 X 2	— ZC ZD ND NF ZF
	Inlet 1	Outlet 3/4	PN	ST	Inlet M33 X 2	Outlet M26 X 1.5	KL
	Outlet 3/4	Inlet 1	NP	TS	Outlet M26 X 1.5	Inlet M33 X 2	LK
	1 1 1/4	1 1 1/4	EE* GG*	RR* SS*	M33 X 2 M42 X 2	M33 X 2 M42 X 2	KK* JJ*
	Inlet 1	Outlet 3/4	SX	PX	M33 X 2	M26 X 1.5	PV
	Outlet 3/4	Inlet 1	XS	XP	M26 X 1.5	M33 X 2	VP

* Code B, EE, RR, KK, GG, SS, and JJ for motors only.
Pump applications must be approved by Technical Service.

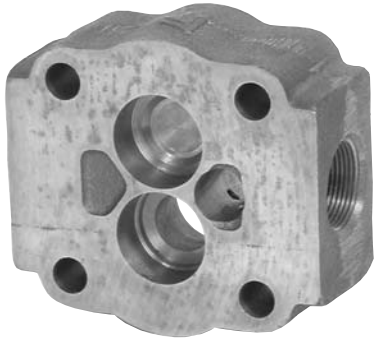

5 Bearing Carriers

P20 BEARING CARRIERS (FLOW DIVIDERS ONLY)

	Ports				Ports				Ports			
	Porting		NPT Code	BSSP Code	Porting		SAE Split Flge. Code	Metric Split Flge. Code	Porting		SAE Str. Thd. Code	Metric Str. Thd. Code
	LH	RH			LH	RH			LH	RH		
	—	—	B	B	—	—	B	B	—	—	B	B
	—	—	E	E	—	—	E	E	—	—	E	E
	1 1 1/4 1 1/2	— — —	M N —	X Y Z	1 1 1/4 1 1/2	— — —	J K L	T V W	1 1 1/4 1 1/2 M33 X 2 M42 X 2 M48 X 2	— — — — — —	F G H — — —	— — — Q R S
	— —	3/4 1	BX KZ	DG DF	— —	3/4 1	GR MT	TR FM	— — —	3/4 1 M26 X 1.5 M33 X 2	GJ BK — —	— — QJ ML
	— —	3/4 1	CV NK	DM MN	— —	3/4 1	FD JG	KT RP	— — —	3/4 1 M26 X 1.5 M33 X 2	JH PC — —	— — BZ MK
	1 1 1/4 1 1/2 1 1/4 1 1/2	3/4 3/4 3/4 1 1	GX HX — LZ —	FG SG XG GF MF	1 1 1/4 1 1/2 1 1/4 1 1/2	3/4 3/4 3/4 1 1	HR PR QR NT RT	VR WR XR QM VM	1 1 1/4 1 1/2 1 1/4 1 1/2 M33 X 2 M42 X 2 M48 X 2 M42 X 2 M48 X 2	3/4 3/4 3/4 1 1 M26 X 1.5 M26 X 1.5 M26 X 1.5 M33 X 2 M33 X 2	HJ MJ RJ PK RK — — — — —	— — — — — SJ XJ ZJ PL QL
	1 1 1/4 1 1/2 1 1/4 1 1/2	3/4 3/4 3/4 1 1	GV MV — TK —	NM PM TM QN TN	1 1 1/4 1 1/2 1 1/4 1 1/2	3/4 3/4 3/4 1 1	GD MD PD PG RG	PT QT ZT TP ZP	1 1 1/4 1 1/2 1 1/4 1 1/2 M33 X 2 M42 X 2 M48 X 2 M42 X 2 M48 X 2	3/4 3/4 3/4 1 1 M26 X 1.5 M26 X 1.5 M26 X 1.5 M33 X 2 M33 X 2	PH RH WH QC VC — — — — —	— — — — — PZ QZ YZ QK SK
	1	3/4	VG	HP	1	3/4	WL	FP	1 M33 X 2	3/4 M26 X 1.5	MC —	— CP
	1	3/4	WG	LP	1	3/4	ZL	GP	1 M33 X 2	3/4 M26 X 1.5	SC —	— DP

ntertech Cylinders, Pumps & Motors / Custom Hoists / LHA
Accessories / Cylinders / Prince Cylinders & Pumps / Chief
Cylinders / Perfection Pumps / White Motors / Gresen®
Cylinders, Pumps, Motors & Valves / Commercial Intertech
Cylinders, Pumps & Motors / Custom Hoists / LHA Accessories
Cylinders / Prince Cylinders & Pumps / Chief Cylinders /
Perfection Pumps / White Motors / Gresen® Cylinders, Pumps,
Motors & Valves / Commercial Intertech Cylinders, Pumps &
Motors / Custom Hoists / LHA Accessories / Cylinders / Prince
Cylinders & Pumps / Chief Cylinders / Perfection Pumps / White
Motors / Gresen® Cylinders, Pumps, Motors & Valves /
Commercial Intertech Cylinders, Pumps & Motors / Custom
Hoists / LHA Accessories / Cylinders / Prince Cylinders &
Pumps / Chief Cylinders / Perfection Pumps / White Motors /
Gresen® Cylinders, Pumps, Motors & Valves / Commercial
Intertech Cylinders, Pumps & Motors / Custom Hoists / LHA
Accessories / Cylinders / Prince Cylinders & Pumps / Chief
Cylinders / Perfection Pumps / White Motors / Gresen®
Cylinders, Pumps, Motors & Valves / Commercial Intertech
Cylinders, Pumps & Motors / Custom Hoists / LHA Accessories
Cylinders / Prince Cylinders & Pumps / Chief Cylinders /
Perfection Pumps / White Motors / Gresen® Cylinders, Pumps,
Motors & Valves / Commercial Intertech Cylinders, Pumps &
Motors / Custom Hoists / LHA Accessories / Cylinders / Prince
Cylinders & Pumps / Chief Cylinders / Perfection Pumps / White
Motors / Gresen® Cylinders, Pumps, Motors & Valves /
Commercial Intertech Cylinders, Pumps & Motors / Custom
Hoists / LHA Accessories / Cylinders / Prince Cylinders &
Pumps / Chief Cylinders / Perfection Pumps / White Motors /
Gresen® Cylinders, Pumps, Motors & Valves / Commercial
Intertech Cylinders, Pumps & Motors / Custom Hoists / LHA
Accessories / Cylinders / Prince Cylinders & Pumps / Chief
Cylinders / Perfection Pumps / White Motors / Gresen®
Cylinders, Pumps, Motors & Valves / Commercial Intertech
Cylinders, Pumps & Motors / Custom Hoists / LHA Accessories
Cylinders / Prince Cylinders & Pumps / Chief Cylinders /
Perfection Pumps / White Motors / Gresen® Cylinders, Pumps

25X



Reliability

Commercial's pumps and motors have always been the most reliable, most efficient in the world. They're cast from high tensile iron for strength, machined precisely for efficiency, and carefully assembled and tested to assure long service life.

Call our Component sales team for quick application assistance and pump specifications.

Performance Data

Performance data shown are the average results based on a series of laboratory tests of production units and are not necessarily representative of any one unit. Tests were run with the oil reservoir temperature at 120°F. Requests for more specific data should be directed to our sales representatives.

Performance data for pumps and motors having other gear widths can be approximated by multiplying values in the tables below by the actual gear width.

Pump Speed rpm	Avg. Output (gpm) @ 2000 psi Gear Width (inches)			
	1	1-1/2	2	2-1/2
900	8.5	13.0	17.5	22.0
1500	15.0	23.0	31.0	39.0
1800	18.0	27.5	37.5	47.0
2100	21.5	32.5	44.0	55.0

Motor Speed rpm	Avg. Input/Output (gpm) @ 2000 psi					
	1" gear		2" gear		2-1/2" gear	
	gpm	hp	gpm	hp	gpm	hp
800	10.5	8.5	21.0	18.0	26.0	23.5
1200	15.5	13.0	30.5	27.5	37.5	35.0
1600	20.0	17.0	40.0	36.5	49.5	44.5
2000	25.0	21.0	49.0	44.5	61.5	54.5

How To Specify and Code

This catalog contains codes for our most popular models. Complete codes for all configurations are readily available upon request.

Single Units

Full assembly codes for single units combine shaft end cover, port end cover, gear housing and drive shaft codes. They are preceded by the letter P or M for pump or motor — and by 25X to designate the series and model. An example of an assembly code follows:

M25X SINGLE MOTOR

Assembly Code: **M 25X 942 BE 1T20 -25**

- MotorM
- Series25
- ModelX
- 1. Shaft End Cover942
- 2. Port End CoverBE
- 3. Gear Housing1T20
- 4. Drive Shaft25

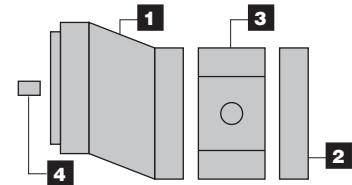

Multiple Units

Coding is the same as single units except that codes for added components must be included. Each gear unit added also requires code for a bearing carrier, the additional gear housing and connecting shaft. An example of an assembly code for a two-section 25X pump follows:

P25X MULTIPLE PUMP

Assembly Code: **P 25X 397 BY RT15 -25 B RT15 -1**

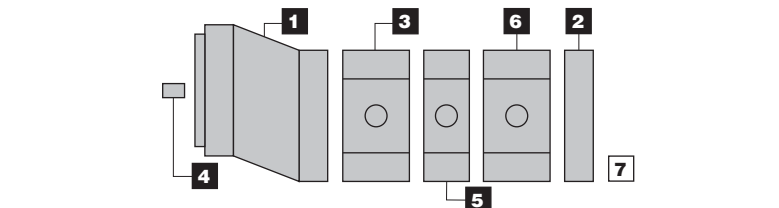

- PumpP
- Series25
- ModelX
- 1. Shaft End Cover397
- 2. Port End CoverBY
- 3. Gear HousingRT15
- 4. Drive Shaft25
- 5. Bearing CoverB
- 6. Gear HousingRT15
- 7. Connecting Shaft1

Variations

25 X units are available with gear sections ranging from 1/2" to 2-1/2" in 1/4" increments which provide displacements from 1.275 to 6.375 cu. in. per revolution. Two or more gear sections can be assembled on one drive shaft to provide larger flows, supply other circuits or make smoother, more powerful motors.

When specifying multiple units you must consider the drive shaft's strength. This is called a PL factor in which P = operating pressure and L = sum of gear widths. The recommended PL factors for various 25X shafts are shown with the shaft codes and are offered as a guide to shaft selection. A PL of 8000 means a maximum of 4" of gear can be operated at 2000 psi (2000 psi X 4" = 8000) without overloading the shaft. The gear widths can be divided many ways, eg. (2"-1"-1", 1"-1"-1"-1", 1-1/2"-1-1/2"-1/2") to provide the output you need for several circuits.

25X Parts Breakdown Typical Parts List

For Series 25X Seal Kits and Repair Parts, See Pages 475 - 477

Note:

Commercial Model 25X tandem pumps and motors can be furnished with either the Type I or Type II shaft. The Type II shaft is used with a thrust bearing and a needle bearing in place of the tapered roller bearing used in the Type I, in order to provide for the 6 bolt — 2⁵/₁₆" dia. pilot shaft end cover. Subassemblies are not interchangeable.

Due to a change in seals, items 31 and 35 are no longer applicable and have been deleted on this exploded view.

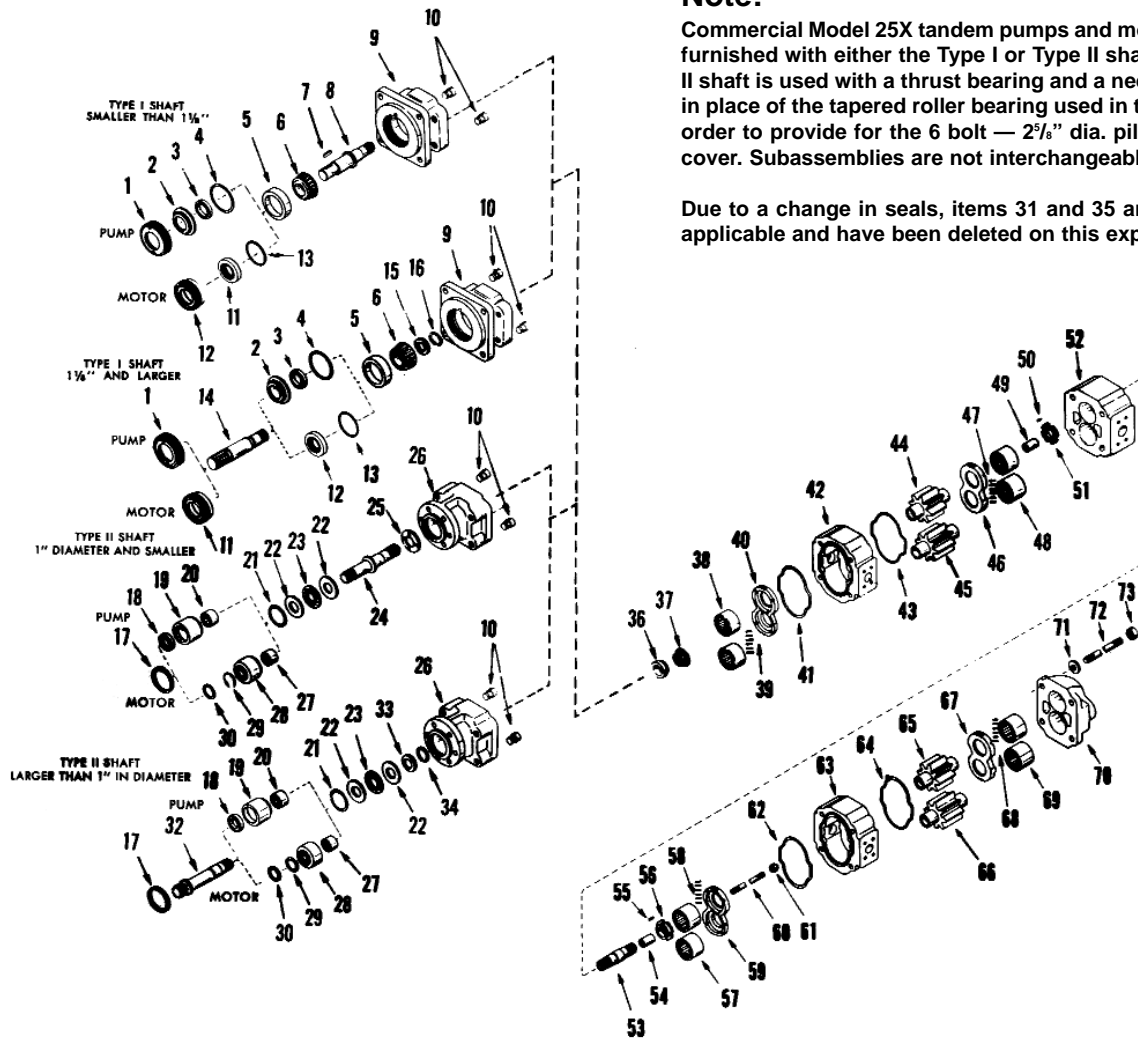

Item	Description	Part Number	Item	Description	Part Number	Item	Description	Part Number
1	Retainer Ring	CM-391-2581-009	25	Thrust Washer		50	Roll Pin	
2	Seal Retainer	CM-391-2584-016	26	Shaft End Cover		51	Shaft Bushing	
3	Double Lip Seal	CM-391-2883-055	27	Needle Bearing		52	Bearing Carrier	
4	"O" Ring	CM-391-2881-120	28	Bearing & Seal Retainer		53	Connection Shaft	
5	Bearing Cup		29	"O" Ring		54	Spacer	
6	Tapered Bearing	CM-391-0384-008	30	Back-up Ring		55	Roll pin	
7	Key		32	Drive Shaft		56	Shaft Bushings	
8	Drive Shaft		33	Snap Ring Retainer		57	Roller Bearings	
9	Shaft End Cover		34	Snap Ring		58	Pocket Seal	
10	Check Assemblies	CM-391-3681-001	36	Bronze Shaft Bushing	CM-391-0481-002	59	Thrust Plate	CM-391-2185-912
11	Motor Shaft Seal		37	Conical Spring	CM-391-3581-176	60	Connecting Stud	
12	Seal Retainer		38	Roller Bearings		61	Lock Nut	
13	"O" Ring		39	Pocket Seal		62	"O" Ring Gasket	CM-391-2884-021
14	Drive Shaft		40	Thrust Plate	CM-391-2185-912	63	Gear Housing	
15	Spacer		41	"O" Ring Gasket	CM-391-2884-021	64	"O" Ring Gasket	CM-391-2884-021
16	Snap Ring		42	Gear Housing		65	Drive Gear	
17	Spirolox Snap Ring		43	"O" Ring Gasket	CM-391-2884-021	66	Driven Gear	
18	Double Lip Seal		44	Drive Gear		67	Thrust plate	CM-391-2185-912
19	Bearing and Seal Retainer		45	Driven Gear		68	Pocket Seal	
20	Needle Bearing		46	Thrust Plate	CM-391-2185-912	69	Roller Bearings	
21	"O" Ring		47	Pocket Seal		70	Port End Cover	
22	Thrust Bearing Race		48	Roller Bearings	CM-391-0381-905	71	Washer	
23	Thrust Bearing Rollers		49	Spacer		72	Stud	
24	Drive Shaft					73	Hex Nut	

1 & 2 Shaft & Port End Covers

P 25 SHAFT END COVERS

Description	Type	CW	PUMPS		No Drain	MOTORS	
			CCW	Double		1/4" NPT Drain	1/4" BSPP Drain
Pad Mounting Same as D Code 311	1	100	200	300	900	700	1700
Double Outboard Bearing Pad Mounting Same as D Code 312	3			600		800	1800
6 Bolt Round Flange Same as D Code 322	1	101	201	301	901	701	1701
4 Bolt Round Flange Same as D Code 321	1	103	203	303	903	703	1703
6 Bolt Round Flange Same as D Code 324	2	104	204	304	904	704*	1704**
4 Bolt Square Flange "Special" D 391	2	105	205	305	905	705*	1705**
4 Bolt Round Flange for Direct Mount to Spicer to Chelsea PTO	1	106	206	306	906		
SAE "B" 4 Bolt Double Outboard Bearing	2	107	207	307	907		
SAE "B" 4 Bolt	1	142	242	342	942	742	1742
Double Outboard Bearing SAE "B" 4 Bolt	3			642		842	1842
SAE "C" 4 Bolt	1	178	278	378	978	778	1778
Double Outboard Bearing SAE "C" 4 Bolt	3			678		878	1878
SAE "B" 2 Bolt	1	197	297	397	997	797	1797
Double Outboard Bearing SAE "B" 2 Bolt	3			697		897	1897
SAE "C" 2 Bolt	1	198	298	398	998	798	1798

* Codes 704 and 705 will have 1/8" NPT Drain

** Codes 1704 and 1705 will have 1/8" BSPP Drain



PORT END COVERS

FLUSH STYLE - TYPE 1

Description	Multiple Pumps			Porting	
	Single Pumps	w/o Support Studs	With Support Studs	LH	RH
NPT Ports	BE	BI	BY	—	—
	CE	CI	CY	—	3/4
	FE	FI	FY	3/4	—
OD Tube Ports	GE	GI	GY	3/4	3/4
	DE	DI	DY	—	1/2
	HE	HI	HY	1/2	—
	JE	JI	JY	1/2	1/2
	LE	LI	LY	—	3/4
	KE	KI	KY	3/4	—
	ME	MI	MY	3/4	3/4
	UE	UI	UY	5/8	—
	NE	NI	NY	—	5/8



TYPE 2

Description	Code	Rotation
Port End Covers w/ .9996" Keyed Shaft	BO	Double
6 Bolt Round	CO	CCW
4 1/4" Bolt Circle 2.625" Pilot Dia.	DO	CW

4 Gear & Shaft Combinations



P25 GEAR AND SHAFT COMBINATIONS

TYPE I		TYPE I	
Description	Code Number	Description	Code Number
Connecting Shaft for Multiple Pumps	5-1 7-1 10-1 12-1 15-1 17-1 20-1 22-1 25-1	.873" Major Diameter Standard SAE 13 Tooth Spline - Type "B"	5-25 7-25 10-25 12-25 15-25 17-25 20-25 22-25 25-25
1.127" Round Shaft Standard SAE 1/4 x 3/8 x 1 3/4 # 51 P & W Key	5-2 7-2 10-2 12-2 15-2 17-2 20-2 22-2 25-2	Standard SAE Straight Keyed Shaft Type "B" 1/4 x 3/8 x 1" #15 P & W Key	5-30 7-30 10-30 12-30 15-30 17-30 20-30 22-30 25-30
6 Spline 1.120" Major Diameter	5-6 7-6 10-6 12-6 15-6 17-6 20-6 22-6 25-6	.8745" Round Shaft 3/4 x 8/32 x 1 1/4" # 19 P & W Key	5-38 7-38 10-38 12-38 15-38 17-38 20-38 22-38 25-38
Standard SAE 14 Tooth Spline - Type "C" 1.2480" Major Diameter	5-7 7-7 10-7 12-7 15-7 17-7 20-7 22-7 25-7	.8745" Round Shaft # 19 P & W Key 3/16 x 9/32 x 1 1/4	5-39 7-39 10-39 12-39 15-39 17-39 20-39 22-39 25-39
1.250" Diameter Standard SAE Straight Key Shaft Type "C" # 25 P & W Key 5/16 x 13/32 x 1 1/2	5-11 7-11 10-11 12-11 15-11 17-11 20-11 22-11 25-11	6 Spline - 1 3/8" Spline .8730" Major Diameter	5-40 7-40 10-40 12-40 15-40 17-40 20-40 22-40 25-40
6 Spline - 1 5/16" Spline .9846" Major Diameter	5-42 7-42 10-42 12-42 15-42 17-42 20-42 22-42 25-42	.9545" Diameter Straight Keyed Shaft 1/4 x 3/8 x 1 1/4"	5-52 7-52 10-52 12-52 15-52 17-52 20-52 22-52 25-52
.9996" Diameter Round Shaft 1/4 x 5/8 x 1 1/4" #21 P & W Key	5-43 7-43 10-43 12-43 15-43 17-43 20-43 22-43 25-43		

TYPE II	
Description	Code Number
6 Spline - 1 13/16 Spline .8730 Major Diameter Supersedes Code 44	5-99 7-99 10-99 12-99 15-99 17-99 20-99 22-99 25-99
.8745" Diameter Round Shaft 3/16 x 8/32 x 1 1/4" #19 P & W Key	5-45 7-45 10-45 12-45 15-45 17-45 20-45 22-45 25-45
6 Spline - 1 8/32" Spline .9846" Major Diameter	5-46 7-46 10-46 12-46 15-46 20-46 22-46 25-46
.9996" Diameter Round Shaft 1/4 x 3/8 x 1 1/4" # 21 P & W Key	5-47 7-47 10-47 12-47 15-47 20-47 22-47 25-47
SAE "B" 13 Tooth Spline - 1 3/4" Spline .8730" Modified major Diameter	5-48 7-48 10-48 12-48 15-48 20-48 22-48 25-48
14 Tooth Involute Spline - 31/32 1.2480" Major Diameter	5-55 7-55 10-55 15-55 17-55 20-55 22-55 25-55

TYPE II	
Description	Code Number
1.249" Diameter Straight Shaft #55 P & W Key	5-73 7-73 10-73 12-73 15-73 17-73 20-73 22-73 25-73

3 & 6 Gear Housings

25X Gear housings - NPT Ports

Porting		1/2	3/4	1	1 1/4	1 1/2	1 3/4	2	2 1/4	2 1/2
LH	RH									
—	—	AB05	AB07	AB10	AB12	AB15	AB17	AB20	AB22	AB25
—	1/2		AC07							
1/2	—		AP07							
1/2	1/2		EC07	EC10						
—	3/4		AF07	AF10	AF12	AF15	AF17	AF20		
3/4	—		AR07	AR10	AR12	AR15	AR17	AR20		
3/4	3/4			ER10	ER12	ER15	ER17	ER20	ER22	ER25
1/2	3/4		ED07							
3/4	1/2		EH07							
—	1‡			AH10‡	AH12	AH15	AH17	AH20	AH22	AH25
1‡	—			AT10‡	AT12	AT15	AT17	AT20	AT22	AT25
1	1			IL10*	IL12	IL15	IL17	IL20	IL22	IL25
3/4	1‡			ET10‡	ET12	ET15	ET17	ET20	ET22	ET25
1‡	3/4			IJ10‡	IJ12	IJ15	IJ17	IJ20	IJ22	IJ25
—	1 1/4						AJ17	AJ20	AJ22	AJ25
1 1/4	—						AV17	AV20	AV22	AV25
1 1/4	1 1/4						IT17	IT20	IT22	IT25
1 1/2‡	—						AW20‡	AW22	AW25	
—	1 1/2‡						AK20‡	AK22	AK25	
1 1/2	1 1/2							JC22	JC25	
3/4	1 1/4						EU17	EU20		EU25
1 1/4	3/4						IQ17	IQ20		IQ25
1	1 1/4						IM15‡	IM17	IM20	IM25
1 1/4	1						IS15‡	IS17	IS20	IS25
1	1 1/2‡							IN20‡	IN22	IN25
1 1/2‡	1							IY20‡	IY22	IY25
1 1/4	1 1/2‡							IU20‡	IU22	IU25
1 1/2‡	1 1/4							IZ20‡	IZ22	IZ25

‡ Low pressure input only

* Note: To be used only with Technical Service approval.



25X GEAR HOUSINGS - SAE SPLIT FLANGE PORTS

Porting		3/4	1	1 1/4	1 1/2	1 3/4	2	2 1/4	2 1/2		
LH	RH										
—	—	AB07	AB10	AB12	AB15	AB17	AB20	AB22	AB25		
—	1/2	OC07				OC17					
1/2	—	OP07				OP17					
1/2	1/2					ZC17					
—	3/4			OF12	OF15	OF17	OF20	OF22	OF25		
3/4	—			OR12	OR15	OR17	OR20	OR22	OR25		
3/4	3/4		ZR10	ZR12	ZR15	ZR17	ZR20	ZR22	ZR25		
—	1		OH10*	OH12	OH15	OH17	OH20	OH22	OH25		
1	—		OT10*	OT12	OT15	OT17	OT20	OT22	OT25		
1	1			RL12*	RL15	RL17	RL20	RL22	RL25		
—	1 1/4‡			OJ12‡	OJ15	OJ17	OJ20	OJ22	OJ25		
1 1/4‡	—			OV12‡	OV15	OV17	OV20	OV22	OV25		
1 1/4	1 1/4				RT15	RT17	RT20	RT22	RT25		
—	1 1/2‡				OK15‡	OK17‡	OK20	OK22	OK25		
1 1/2‡	—				OW15‡	OW17‡	OW20	OW22	OW25		
1 1/2	1/12					SC17‡	SC20	SC22	SC25		
1 1/2‡	1					RY15‡	RY17‡	RY20	RY22	RY25	
1	1 1/2‡					RN15‡	RN17‡	RN20	RN22	RN25	
1/2	3/4					ZF15	ZF17	ZF20	ZF22	ZF25	
3/4	1/2					ZP15	ZP17	ZP20	ZP22	ZP25	
3/4	1		ZT10			ZT15	AT17	ZT20	ZT22	ZT25	
1	3/4		RJ10			RJ15	RJ17	RJ20	RJ22	RJ25	
1	1 1/4‡					RM12‡	RM15	RM17	RM20	RM22	RM25
1 1/4‡	1					RS12‡	RS15	RS17	RS20	RS22	RS25
1 1/4	3/4					RQ15	RQ17	RQ20	RQ22	RQ25	
3/4	1 1/4					ZU15	ZU17	ZU20	ZU22	ZU25	
1 1/4	1 1/2‡					RU15‡	RU17‡	RU20	RU22	RU25	
1 1/2‡	1 1/4					RZ15‡	RZ17‡	RZ20	RZ22	RZ25	
1 1/2	2‡						SD20‡	SD22‡	SD25		
2‡	1 1/2						SH20‡	SH22‡	SH25		
1 1/4	2‡						RX20‡	RX22‡	RX25		
2‡	1 1/4						SG20‡	SG22‡	SG25		
1	2‡							OS22‡	OS25		
2‡	1							OZ22‡	OZ25		
2	—							OX20‡			
—	2							OL20‡			

‡ Low pressure input only

* Note: To be used only with Technical Service approval.

25X GEAR HOUSINGS - SAE STRAIGHT THREAD PORTS

Porting		3/4	1	1 1/4	1 1/2	1 3/4	2	2 1/4	2 1/2
LH	RH								
—	—	AB07	AB10	AB12	AB15	AB17	AB20	AB22	AB25
—	1/2	UC07	UC10		UC15				
1/2	—	UP07	UP10		UP15				
1/2	1/2	YC07	YC10	YC12	YC15				
—	5/8		UD10	UD12	UD15				
5/8	—		UQ10	UQ12	UQ15				
5/8	5/8		YK10	YK12	YK15		YK20		
—	3/4		UF10	UF12	UF15	UF17			
3/4	—		UR10	UR12	UR15	UR17			
3/4	3/4		YR10	YR12	YR15	YR17	YR20	YR22	YR25
—	7/8			UG12	UG15	UG17	UG20	UG22	UG25
7/8	—			US12	US15	US17	US20	US22	US25
7/8	7/8			YZ12	YZ15	YZ17	YZ20	YZ22	YZ25
—	1‡			UH12‡	UH15	UH17	UH20	UH22	UH25
1‡	—			UT12‡	UT15	UT17	UT20	UT22	UT25
1	1			VL12*	VL15	VL17	VL20	VL22	VL25
—	1 1/4						UJ20	UJ22	UJ25
1 1/4	—						UV20	UV22	UV25
1 1/4	1 1/4						VT20	VT22	VT25
—	1 1/2							UK22	
1 1/2	—							UW22	
5/8	1/2			YJ10		YJ15			
5/8	3/4			YL10	YL12	YL15	YL17		
3/4	5/8			YQ10	YQ12	YQ15	YQ17		
3/4	7/8							YS22	
7/8	3/4							YX22	
7/8	1‡			VC12‡	VC15	VC17	VC20	VC22	VC25
1‡	7/8			VK12‡	VK15	VK17	VK20	VK22	VK25
1	1 1/4‡				VM15‡	VM17‡	VM20	VM22	VM25
1 1/4‡	1				VS15‡	VS17‡	VS20	VS22	VS25
1 1/4	1 1/2‡						VU20‡	VU22	VU25
1 1/2‡	1 1/4						VZ20‡	VZ22	VZ25
3/4	1‡					YT10‡			
1‡	3/4					VJ10‡			
1/2	5/8					YD10			
1	1 1/2‡							VN17‡	
1 1/2‡	1							VG17‡	
1 1/2	1 1/2								WC25







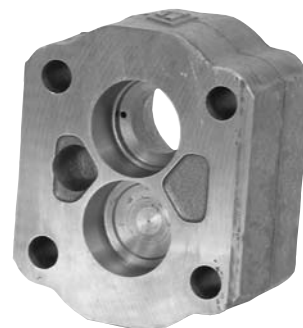



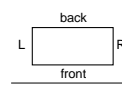













‡ Low pressure input only

* Note: To be used only with Technical Service approval.

5 Bearing Carriers



25X BEARING CARRIERS

	Porting		NPT Ports	BSPP	SAE Split	Metric Split	SAE Straight	Metric Straight
	LH	RH	Code	Code	Flange Code	Flange Code	Thread Code	Thread Code
	—	—	B	—	—	—	—	—
	—	—	C	—	—	—	—	—
	—	—	H	—	—	—	—	—
	3/4	—	D	MD	FL	XX	ND	NH
	1	—	F	MG	FM	XL	NF	NM
	1 1/4	—	G	MH	FN	XM	NG	NN
	1 1/2	—	TL	MM	FP	XN	TH	NO
	—	3/4	J	MO	FQ	XO	—	NP
	—	1	L	MQ	FR	XP	NJ	NQ
	—	1 1/4	L	MS	FS	XQ	NK	NZ
	—	1 1/2	TJ	MX	FT	CQ	TM	ZZ
	1	3/4	CV	—	—	—	—	—
	3/4	1	CW	HO	KZ	JN	TS	RE
	1 1/4	1	DB	—	LD	—	—	—
	3/4	1 1/4	—	HR	—	JO	—	RI
	1	1 1/4	DC	HV	LF	JQ	XZ	RO
	1 1/4	1 1/2	—	—	LK	—	—	—
	1 1/2	1 1/4	—	—	LJ	—	—	—
	1	1 1/2	XT	HX	XW	JR	TN	RR
	3/4	1 1/2	XR	HS	XF	JP	—	RK
	3/4	3/4	CT	—	KW	—	—	—
	1	1	CZ	—	LC	—	PX	—
	1 1/4	1 1/4	DF	—	—	—	—	—
	1 1/2	1 1/2	—	—	LM	—	—	—
	1 1/4	1	BN	HM	HB	JL	XX	PS
	1	1 1/4	BP	—	HC	—	—	—
	1 1/2	1	XS	HN	XV	JM	TK	PV
	1	3/4	BJ	HD	GV	JD	—	PN
	3/4	3/4	BH	—	GT	—	NX	—
	1	1	BM	—	—	—	PB	—
	1 1/4	1 1/4	SR	—	HF	—	PD	—
	1 1/2	1 1/2	—	—	HK	—	—	—
	1 1/2	3/4	XH	HL	—	JK	—	PR
	1 1/2	1 1/4	—	—	HG	—	—	—
	1 1/4	1 1/2	—	—	HH	—	—	—
	3/4	1	BW	EG	HP	LH	—	SJ
	1	1 1/4	CC	BV	HT	LW	XD	SO
	1	1 1/2	TV	QV	TX	LX	TZ	SP
	3/4	3/4	BT	—	—	—	—	—
	1	1	BZ	—	—	—	PJ	—
	1 1/4	1 1/4	CF	—	HW	—	PL	—
	1 1/4	1	CB	—	—	—	—	—
	1 1/2	1 1/2	—	—	KC	—	—	—
	1	3/4	CJ	QC	KG	KB	—	GD
	3/4	1	CK	—	KH	—	—	—
	1 1/4	1	CN	QN	KL	KR	XC	GX
	1	1 1/4	CP	—	KM	—	—	—
	1 1/2	1	TT	QO	TW	KX	—	GZ
	3/4	3/4	CH	—	KF	—	—	—
	1	1	CM	—	—	—	PQ	—
	1 1/4	1 1/4	CR	—	—	—	—	—
	1 1/2	1 1/2	—	—	KT	—	—	—
	3/4	—	CS	—	KV	—	PT	—
	1	—	CX	—	LB	—	PW	—
	1 1/4	—	DD	—	LG	—	PZ	—
	—	3/4	BG	—	—	—	NW	—
	—	1	BL	—	—	—	—	—
	—	1 1/4	—	—	—	—	PC	—
	3/4	—	BS	—	—	—	PI	—
	1	—	BX	—	HQ	—	PH	—
	1 1/4	—	CD	—	—	—	—	—



5 Bearing Carriers

25X BEARING CARRIERS

	Porting		NPT Ports	BSPP	SAE Split	Metric Split	SAE Straight	Metric Straight
	LH	RH	Code	Code	Flange Code	Flange Code	Thread Code	Thread Code
	—	3/4	CG	—	KD	—	—	—
	—	1	CL	—	KJ	—	PP	—
	—	1 1/4	—	—	KN	—	—	—
	—	1 1/2	—	—	KS	—	—	—
	3/4	3/4	Q	—	—	—	—	—
	1	3/4	R	—	FZ	—	—	—
	3/4	1	S	—	GB	—	—	—
	1 1/4	1	X	—	GG	—	—	—
	1	1 1/4	BB	—	GH	—	—	—
	1 1/2	—	—	—	GO	—	—	—
	1	1	W	OB	GF	QB	NR	RA
	1 1/4	1 1/4	BF	OE	GL	QZ	NV	XJ
1 1/2	1 1/2	TQ	ON	GR	BK	TP	JG	
	3/4	—	P	—	—	—	—	—
	1	—	V	—	—	—	—	—
	1 1/4	—	BD	—	GK	—	NT	—
	—	3/4	N	—	—	—	NL	—
	—	1	T	—	GC	—	—	—
	—	1 1/4	BC	—	GJ	—	NS	—
	3/4	3/4	DG	AL	LN	JS	—	GM
	1	1	DH	AS	LP	JT	QD	GN
	1 1/4	1 1/4	DJ	AZ	LQ	JX	AF	GO
	1 1/2	1 1/2	—	HZ	LR	JZ	—	GP
	3/4	3/4	DK	KK	—	FO	—	SS
	1	1	DL	LL	LT	FV	QH	ST
	1 1/4	1 1/4	DM	VV	LV	FW	QJ	SV
	1 1/2	1 1/2	—	WW	—	FX	—	SW
	3/4	—	DZ	—	MN	—	—	—
	1	—	FB	—	MP	—	QW	—
	1 1/4	—	FC	—	—	—	QX	—
	1 1/2	—	—	—	MR	—	—	—
	—	3/4	FD	—	—	—	—	—
	—	1	FF	—	MT	—	TB	—
	—	1 1/4	FG	—	MV	—	TC	—
	—	1 1/2	—	—	MW	—	—	—
	—	3/4	DV	—	MJ	—	QR	—
	—	1	DW	—	MK	—	QS	—
	—	1 1/4	DX	—	ML	—	QT	—
	3/4	—	FH	—	—	—	TD	—
	1	—	FJ	—	MZ	—	TF	—
	1 1/4	—	FK	—	NB	—	TG	—
	1 1/2	—	—	—	NC	—	—	—
	3/4	3/4	DR	—	—	—	—	—
	1	1	DS	—	MF	—	QP	—
	1 1/4	1 1/4	DT	—	—	—	QQ	—
	3/4	3/4	DN	—	—	—	QK	—
	1	1	DP	—	LZ	—	QL	—
	1 1/4	1 1/4	DQ	—	MB	—	—	—
	1 1/2	1 1/2	—	—	MC	—	—	—
	—	—	M	—	—	—	—	—

P30

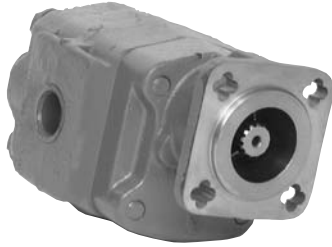

Reliability

Series 30 pumps and motors are cast from hi-tensile gray iron and offer a wide variety of drive shafts designed for high torque input/output. Unique pressure balanced thrust plates contribute to operating efficiencies of over 90%.

These units are designed for continuous operation in heavy-duty implement circuits. They're equally at home on lift trucks, auto wreckers and small dump body applications.

Call our Component sales team for quick application assistance and pump specifications.

Performance Data

Performance data shown are the average results based on a series of laboratory tests of production units and are not necessarily representative of any one unit. Tests were run with the oil reservoir temperature at 120°F. Requests for more specific data should be directed to our sales representatives.

Performance data for pumps and motors having other gear widths can be approximated by multiplying values in tables below by actual gear width.

Pump Speed rpm	Avg. Output (gpm) @ 2000 psi Gear Width (inches)				
	1	1-1/4	1-1/2	1-3/4	2
900	6.5	8.0	10.0	12.0	13.5
1200	9.0	11.5	14.0	16.0	18.5
1500	11.5	14.5	17.5	20.5	23.5
2100	16.5	21.0	25.0	29.0	34.0

Motor Speed rpm	Avg. Input/Output (gpm) @ 2000 psi					
	1" gear		1-1/2" gear		2" gear	
rpm	gpm	hp	gpm	hp	gpm	hp
800	9.0	7.0	13.0	11.0	17.0	14.5
1200	13.0	10.5	18.0	16.5	23.5	22.0
1600	16.4	14.0	23.0	22.0	30.5	29.0
2000	19.5	17.5	28.0	27.0	37.0	36.0

How To Specify and Code

This catalog contains codes for our most popular models. Complete codes for all configurations are readily available upon request.

Single Units

Full assembly codes for single units combine shaft end cover, port end cover, gear housing and drive shaft codes. They are preceded by the letter P or M for pump or motor — and by 30 to designate the series and model. An example of an assembly code follows:

M30 SINGLE MOTOR

Assembly Code: **M 30A 942 BE YF15-30**

- MotorM
- Series30
- ModelA
- 1. Shaft End Cover942
- 2. Port End CoverBE
- 3. Gear HousingYF15
- 4. Drive Shaft30

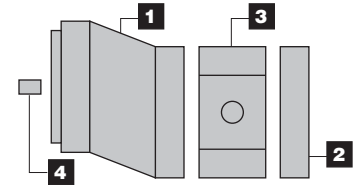

Multiple Units

Coding is the same as single units except that codes for added components must be included. Each gear unit added also requires code for a bearing carrier, the additional gear housing and connecting shaft. An example of an assembly code for a two-section Series 30 pump follows:

P30 MULTIPLE PUMP

Assembly Code: **P 30B 278 BY OM20-43 D UG10-1**

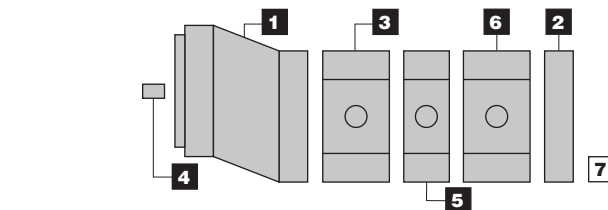

- PumpP
- Series30
- ModelB

- 1. Shaft End Cover278
- 2. Port End CoverBY
- 3. Gear HousingOM20
- 4. Drive Shaft43
- 5. Bearing CoverD
- 6. Gear HousingUG10
- 7. Connecting Shaft1

Variations

Series 30 units are available with gear sections ranging from 1/2" to 2" in 1/4" increments which provide displacements from .985 to 3.94 cu. in. per revolution. Two or more gear sections can be assembled on one drive shaft to provide larger flows, supply other circuits or make smoother, more powerful motors.

When specifying multiple units you must consider the drive shaft's strength. This is called a PL factor in which P = operating pressure and L = sum of gear widths. The recommended PL factors for various Series 30 shafts are shown with the shaft codes and are offered as a guide to shaft selection. A PL of 8000 means a maximum of 4" of gear can be operated at 2000 psi (2000 psi X 4" = 8000) without overloading the shaft. The gear widths can be divided many ways, eg. (2"-1"-1", 1"-1"-1"-1", 1-1/2"-1-1/2"-1/2") to provide the output you need for several circuits.

P30 Parts Breakdown Typical Parts List

For Series P30 Seal Kits and Repair Parts, See Pages 475 - 477

Note:

This page shows the typical arrangement of a 2-section unit. It may not be pictorially correct and is not to scale.

Plug 5 in position B gives clockwise rotation.

Plug 5 in position A gives counter-clockwise rotation.

Check valves in both positions give bi-directional rotation.

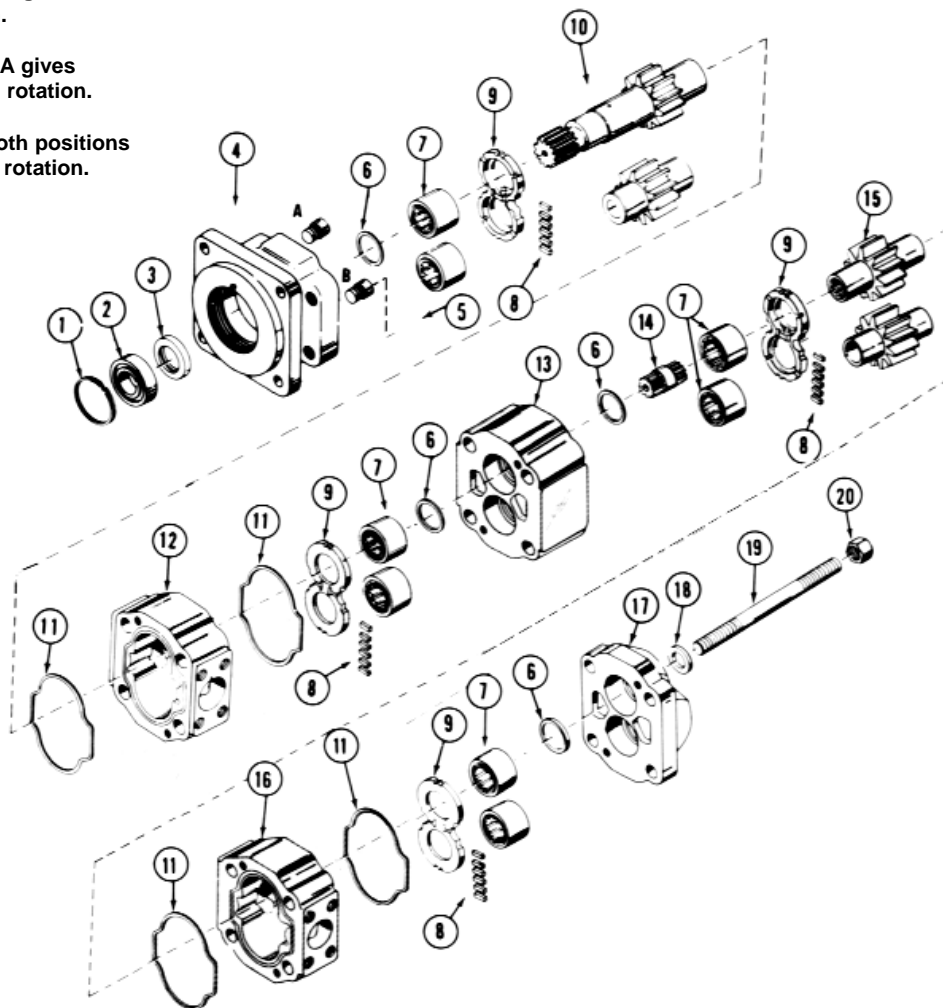

Item	Description	Part Number	Item	Description	Part Number
1	Snap Ring	CM-391-2686-063	10	Integral Drive Shaft and Gear Set	See Option List
2	Outboard Bearing	CM-391-0381-040	11	Gasket Seals	CM-391-2884-050
3	Seal (Pump)	CM-391-2883-058	12	Gear Housing	See Option List
	Hi Pressure Seal (Motor)	CM-391-2883-119	13	Bearing Carrier	See Option List
4	Shaft End Cover	See Option List	14	Connecting Shaft	See Option List
5	Check Assemblies	CM-391-3681-001	15	Matched Gear Set	See Option List
	Plug	CM-391-2286-004	16	Gear Housing	See Option List
6	Ring Seals	CM-391-2585-006	17	Port End Cover	See Option List
7	Roller Bearings	CM-391-0381-906	18	Washers	
8	Pocket Seals		19	Studs or Cap Screws	
9	Thrust Plates	CM-391-2185-913	20	Nuts	

1 & 2 Shaft & Port End Covers

P30 SHAFT END COVERS

Description	Type	Outboard Bearing	PUMPS			MOTORS		
			CW	CCW	Double	1/4" NPT DRAIN	1/4" BSPP DRAIN	
Round Flange - 6 Bolt	1	Without	105	205	305	905	1905	
		With	405	505	605	805	1805	
SAE B - 4 Bolt	1	Without	142	242	342	942	1942	
		With	442	542	642	842	1842	
SAE C - 4 Bolt	1	Without	178	278	378	978	1978	
		With	478	578	678	878	1878	
SAE A - 2 Bolt	1	Without	194	294	394	994	1994	
		With	494	594	694	894	1894	
SAE B - 2 Bolt	1	Without	197	297	397	997	1997	
		With	497	597	697	897	1897	
Piggy Back Shaft End Cover	2	Without	196*	296*	396*	N/A	N/A	
		50-30	Without	191	291	391	N/A	N/A
		30-30	Without	192	292	392	N/A	N/A
Pad Mounting	1	Without	N/A					
		With	400	500	600	800	1800	

* Available for special application upon request.
NOT A STOCK ITEM

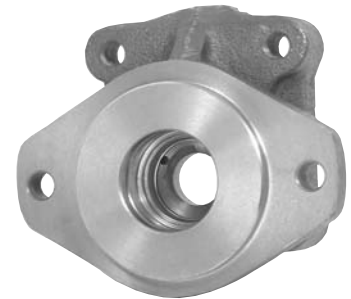

P30 PORT END COVERS

Description	Single Pumps	Multiple Pumps		Porting	
		w/Reg Studs	w/2 Ext Studs	LH	RH
No Ports	BE	BI	BY	—	—
NPT Ports	KE*	KI	KY	3/4	—
	LE*	LI	LY	—	3/4
	ME*	MI	MY	3/4	3/4
ODT Ports	CE*	CI	CY	3/4	—
	DE*	DI	DY	—	3/4
	FE*	FI	FY	3/4	3/4
	GE*	GI	GY	1	3/4
	HE	HI	HY	3/4	1
	JE*	JI*	JY*	1	1
BSPP Ports	WE	WI	WY	3/4	—
	XE	XI	XY	—	3/4
	ZE	ZI	ZY	3/4	3/4
Metric Straight Thread Ports	NE	NI	NY	M26X1.5	—
	PE	PI	PY	—	M26X1.5
	QE	QI	QY	M26X1.5	M26X1.5
	RE	RI	RY	M33X2	M26X1.5
	SE	SI	SY	M26X1.5	M33X2
Piggyback Port End Cover	TYPE 30—30	CW KO	CCW LO	DOUBLE MO	

Priority Outlet see P1B-H2 for description of codes

*Available for special application upon request.

NOT A STOCK ITEM.



4 Drive Shafts



P30 DRIVE SHAFTS

Shaft Description	Code		
	Type 1	Type 2	
SAE B - Straight Keyed .875" Diameter - 1/4" X 1" Key	30	—	
Standard - Straight Keyed .9998" Diameter - 1/4" X 1 1/4" Key	43	—	
SAE B - 13 Tooth Spline .873 Major Diameter	25	65*	
Standard - 6 Tooth Spline .997" Major Diameter	68*	—	
SAE A - 9 Tooth Spline .623" Major Diameter	95	—	
Connecting Shaft - Multiple Units	1	1	
Connecting Shaft - Piggyback Pump	P30 to P30	14	—
	P50 to P30	22	—
	P75 to P30	23	—

* Available for special application upon request. Not a stock item.

P30 DRIVE SHAFT CODE

GEAR WIDTH	1-14-22-23	25	30	43	65*	68*	95
1/2	•						
3/4	•	•	•	•			
1	•	•	•	•	•	•	•
1 1/4	•	•	•	•	•	•	•
1 1/2	•	•	•	•	•	•	•
1 3/4	•	•	•	•	•	•	•
2	•	•	•	•	•	•	•

3 & 6 Gear Housings



30 GEAR HOUSINGS - NPT PORTS

Porting		1/2	3/4	1	1 1/4	1 1/2	1 3/4	2
LH	RH							
—	—	AB05	AB07	AB10	AB12	AB15	AB17	AB20
1/2	—		IL07	IL10				
—	1/2		IM07	IM10				
1/2	1/2		IR07					
3/4	—			IC10	IC12	IC15		
—	3/4			ID10	ID12	ID15		
3/4	3/4			IF10	IF12	IF15	IF17	IF20
3/4	1‡			IG10‡	IG12			
1‡	3/4			IJ10	IJ12	IJ15	IJ17	
1	—				YC12	YC15	YC17	
—	1				YD12	YD15	YD17	
1	1				YF15	YF17	YF17	YF20
1	1 1/4‡					YG15‡	YG17	YG20
1 1/4‡	1					YJ15‡	YJ17	YJ20
1 1/4	1 1/4							YL20
1 1/4‡	—					IA15‡	IA17	IA20
—	1 1/4‡					IB15‡	IB17	IB20
1 1/4	1 1/2‡							YM20‡
1 1/2‡	1 1/4							YP20‡
1 1/2‡	—							YA20‡
—	1 1/2‡							YB20‡

‡ Low pressure only

3 & 6 Gear Housings



P30 GEAR HOUSINGS - METRIC SPLIT FLANGE PORTS

Porting		1/2	3/4	1	1 1/4	1 1/2	1 3/4	2
LH	RH							
—	—	AB05	AB07	AB10	AB12	AB15	AB17	AB20
3/4	—			VN10	VN12	VN15	VN17	
—	3/4			VQ10	VQ12	VQ15	VQ17	
3/4	3/4			VS10	VS12			
3/4	1			VT10	VT12	VT15	VT17	
1	3/4			RV10	RV12	RV15	RV17	
3/4	1 1/4				RU12		RU17	
1 1/4	3/4				RW12		RW17	
1	—			UL10	UL12	UL15	UL17	UL20
—	1			UR10	UR12	UR15	UR17	UR20
1	1				UM12	UM15	UM17	
1	1 1/4				VU12	VU15	VU17	VU20
1 1/4	1				UX12	UX15	UX17	UX20
1	1 1/2						HO17	HO20
1 1/2	1						VO17	VO20
1 1/4	—					NO15		NO20
—	1 1/4					UO15		UO20
1 1/4	1 1/4					PO15	PO17	PO20
1 1/4	1 1/2						QO17	QO20
1 1/2	1 1/4						SO17	SO20
1 1/2	—					UY15	UY17	
—	1 1/2					TO15	TO17	

‡ Low Pressure Only

P30 GEAR HOUSINGS - BSPP PORTS

Porting		1/2	3/4	1	1 1/4	1 1/2	1 3/4	2
LH	RH							
—	—	AB05	AB07	AB10	AB12	AB15	AB17	AB20
3/4	—		YN07	YN10	YN12	YN15	YN17	YN20
—	3/4		YQ07	YQ10	YQ12	YQ15	YQ17	YQ20
3/4	3/4			YS10	YS12	YS15	YS17	YS20
3/4	1			YT10	YT12			
1	3/4			YV10	YV12	YV15	YV17	YV20
3/4	1 1/4					YU15	YU17	YU20
1 1/4	3/4					YW15	YW17	YW20
1	—				SL12	SL15	SL17	SL20
—	1				RQ12	RQ15	RQ17	RQ20
1	1				MP12*	MP15	MP17	
1	1 1/4					VY15	VY17	VY20
1	1 1/2						HW17	HW20
1 1/4	1					IX15	IX17	IX20
1 1/4	—						NJ17	NJ20
—	1 1/4						UI17	UI20
1 1/4	1 1/4							PF20
1 1/2	1 1/4							IS17

‡ Low pressure only

P30 GEAR HOUSINGS - SAE SPLIT FLANGE PORTS

Porting		1/2	3/4	1	1 1/4	1 1/2	1 3/4	2
LH	RH							
—	—	AB05	AB07	AB10	AB12	AB15	AB17	AB20
3/4	—			UC10	UC12			
—	3/4			UD10	UD12	UD15		
3/4	3/4			UF10				
3/4	1			UG10	UG12			UG20
3/4	1 1/4				UH12			
1	3/4			UJ10	UJ12	UJ15	UJ17	UJ20
1 1/4	3/4				UK12			
1	—				OC12	OC15	OC17	
—	1				OD12	OD15	OD17	OD20
1	1			OF10	OF12	OF15	OF17	OF20
1	1 1/4				OG12	OG15	OG17	OG20
1 1/4	1				OJ12	OJ15	OJ17	OJ20
1	1 1/2						OH17	OH20
1 1/2	1						OK17	OK20
1 1/4	—				OA12	OA15	OA17	OA20
—	1 1/4				OB12	OB15	OB17	OB20
1 1/4	1 1/4					OL15	OL17	OL20
1 1/4	1 1/2						OM17	OM20
1 1/2	1 1/4						OP17	OP20
1 1/2	—						OE17	OE20
—	1 1/2						OU17	OU20

‡ Low Pressure Only

P30 GEAR HOUSINGS - SAE STRAIGHT THREAD PORTS

Porting		1/2	3/4	1	1 1/4	1 1/2	1 3/4	2
LH	RH							
—	—	AB05	AB07	AB10	AB12	AB15	AB17	AB20
3/4	—			EC10	EC12	EC15		
—	3/4			ED10	ED12	ED15		
3/4	3/4			EF10	EF12	EF15	EF17	EF20
3/4	1			EG10	EG12	EG15	EG17	
3/4	1 1/4					EH15	EH17	
3/4	1 1/2							IN20
1	3/4			EJ10	EJ12	EJ15	EJ17	EJ20
1 1/4	3/4					EL15	EK17	
1 1/2	3/4							IP20
7/8	—					EZ12		
7/8	1			EL10	EL12			
1	7/8			EM10	EM12			
1	—			AC10	AC12	AC15	AC17	AC20
—	1			AD10	AD12	AD15	AD17	AD20
1	1					AF15	AF17	AF20
1	1 1/4					AG15	AG17	AG20
1	1 1/2						AH17	AH20
1 1/4	1					AJ15	AJ17	AJ20
1 1/2	1						AK17	AK20
1 1/4	—					AA15	AA17	
—	1 1/4					AO15	AO17	
1 1/4	1 1/4						AL17	AL20
1 1/4	1 1/2						AM17	AM20
1 1/2	1 1/4						AP17	AP20
1 1/2	—						AE17	AE20
—	1 1/2						AU17	AU20

‡ Low pressure only

3 & 6 Gear Housings



P30 GEAR HOUSINGS - METRIC STRAIGHT THREAD PORTS

Porting		1/2	3/4	1	1 1/4	1 1/2	1 3/4	2
LH	RH							
—	—	AB05	AB07	AB10	AB12	AB15	AB17	AB20
3/4	—			EN10	EN12			
—	3/4			TQ10	TQ12	TQ15		
3/4	3/4			ES10	ES12			
3/4	1 1/4			ET10‡	ET12‡			
1 1/2	3/4			EV10‡	EV12‡	EV15	EV17	
1 1/2	—			NL10‡		NL15		
—	1 1/2			ER10‡		ER15	ER17	ER20
1	1				CM12*‡	CM15		
1	1 1/4‡					VE15‡	VE17‡	VE20‡
1 1/4‡	1					EX15‡	EX17‡	EX20‡
1 1/4	1 1/4						PA17*	PA20*
1 1/4	1 1/2							QA20*
1 1/2	1 1/4							SA20*

*Rated to 2000 PSI maximum









‡Low pressure only

Port Size	Metric Straight Thread Size
3/4	M26 X 1.5
1	M33 X 2
1 1/4	M42 X 2
1 1/2	M48 X 2

5 Bearing Carriers



P30 BEARING CARRIERS (FLOW DIVIDERS ONLY)

L	back	R	Ports				Ports				Ports			
			Porting		NPT Code	BSSP Code	Porting		SAE Split Flge. Code	Metric Split Flge. Code	Porting LH	Porting RH	SAE Str. Code	Metric Str. Thd. Code
			LH	RH			LH	RH						
	—	—	B	B	—	—	B	B	—	—	B	B		
	—	—	E	E	—	—	E	E	—	—	E	E		
	1	—	M	X	1	—	J	T	1	—	F	—		
	1 1/4	—	N	Y	1 1/4	—	K	V	1 1/4	—	G	—		
	1 1/2	—	—	Z	1 1/2	—	L	W	1 1/2	—	H	—		
	—	3/4	BX	DG	—	3/4	GR	TR	—	3/4	GJ	—		
	—	1	KZ	DF	—	1	MT	FM	—	1	BK	—		
	—	—	—	—	—	—	—	—	—	M26 X 1.5	—	QJ		
	—	3/4	CV	DM	—	3/4	FD	KT	—	3/4	JH	—		
	—	1	NK	MN	—	1	JG	RP	—	1	PC	—		
	—	—	—	—	—	—	—	—	—	M26 X 1.5	—	BZ		
	1	3/4	GX	FG	1	3/4	HR	VR	1	3/4	HJ	—		
	1 1/4	3/4	HX	SG	1 1/4	3/4	PR	WR	1 1/4	3/4	MJ	—		
	1 1/2	3/4	—	XG	1 1/2	3/4	QR	XR	1 1/2	3/4	RJ	—		
	1 1/4	1	LZ	GF	1 1/4	1	NT	QM	1 1/4	1	PK	—		
	1 1/2	1	—	MF	1 1/2	1	RT	VM	1 1/2	1	RK	—		
	—	—	—	—	—	—	—	—	M33 X 2	M26 X 1.5	—	SJ		
	—	—	—	—	—	—	—	—	M42 X 2	M26 X 1.5	—	XJ		
	—	—	—	—	—	—	—	—	M48 X 2	M26 X 1.5	—	ZJ		
	—	—	—	—	—	—	—	—	M42 X 2	M33 X 2	—	PL		
	—	—	—	—	—	—	—	—	M48 X 2	M33 X 2	—	QL		
	1	3/4	GV	NM	1	3/4	GD	PT	1	3/4	PH	—		
	1 1/4	3/4	MV	PM	1 1/4	3/4	MD	QT	1 1/4	3/4	RH	—		
	1 1/2	3/4	—	TM	1 1/2	3/4	PD	ZT	1 1/2	3/4	WH	—		
	1 1/4	1	TK	QN	1 1/4	1	PG	TP	1 1/4	1	QC	—		
	1 1/2	1	—	TN	1 1/2	1	RG	ZP	1 1/2	1	VC	—		
	—	—	—	—	—	—	—	—	M33 X 2	M26 X 1.5	—	PZ		
	—	—	—	—	—	—	—	—	M42 X 2	M26 X 1.5	—	OZ		
	—	—	—	—	—	—	—	—	M48 X 2	M26 X 1.5	—	YZ		
	—	—	—	—	—	—	—	—	M42 X 2	M33 X 2	—	QK		
	—	—	—	—	—	—	—	—	M48 X 2	M33 X 2	—	SK		
	1	3/4	VG	HP	1	3/4	WL	FP	1	3/4	MC	—		
	—	—	—	—	—	—	—	—	M33 X 2	M26 X 1.5	—	CP		
	1	3/4	WG	LP	1	3/4	ZL	GP	1	3/4	SC	—		
—	—	—	—	—	—	—	—	—	M33 X 2	M26 X 1.5	—	DP		

P30 BEARING CARRIERS (PUMPS ONLY)

5 Bearing Carriers

L back front R	Porting		NPT Parts Code	SAE Split Flange Code	SAE Straight Thread Code
	LH	RH			
	—	—	B Motor Only	—	—
	—	—	C	—	—
	—	—	D	—	—
	1	—	TB	LB	CB
	1 1/4	—	VB	MN	DB
	1 1/2	—	—	NB	FB
	—	1	BT	BL	BC
	—	1 1/4	BV	BM	BD
	—	1 1/2	—	BN	BF
	Inlet —	Outlet 3/4	—	BR	—
	1	3/4	TX	LR	CJ
	1 1/4	3/4	VX	MR	DJ
	1 1/4	1	VZ	MS	DK
	1 1/2	1	—	NS	FK
	1 1/2	3/4	—	NR	FJ
	Outlet 3/4	Inlet 1	JT	XL	RC
	3/4	1 1/4	JV	XM	RD
	1	1 1/4	KV	ZM	SD
	1	1 1/2	—	ZN	SF
	3/4	1 1/2	—	XN	RF
	Inlet 1	Outlet 3/4	TJ	LX	CR
	1 1/4	3/4	VJ	MX	DR
	1 1/4	1	VK	MZ	DS
	1 1/2	1	—	NZ	FS
	1 1/2	3/4	—	NX	FR
	Outlet 3/4	Inlet 1	XT	RL	JC
	3/4	1 1/4	XV	RM	JD
	1	1 1/4	ZV	SM	KD
	1	1 1/2	—	SN	KF
	3/4	1 1/2	—	RN	JF
	3/4	—	—	RB	JP
	Inlet 1	Outlet 3/4	ZX	SR	KJ
	Outlet 3/4	Inlet 1	XZ	RS	JK
	Inlet 1	Outlet 3/4	ZS	RZ	KX
	3/4	1	SZ	ZR	XK
	Motors Only 1	1	TT	LL	CC
	1 1/4	1 1/4	VV	MM	BB
	1 1/2	1 1/2	—	NN	FF

Pump applications must be approved by Technical Service.

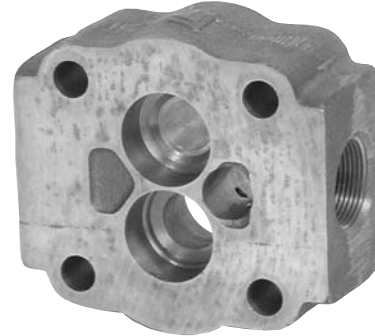

P30 BEARING CARRIERS (PUMPS ONLY)

L back front R	Porting		BSPP Ports Code	Metric Split Flange Code	Porting		Metric Straight Thread Code
	LH	RH			LH	RH	
	—	—	B*	B*	—	—	B*
	—	—	C	C	—	—	C
	—	—	D	D	—	—	D
	1	—	CX	CH	M33 X 2	—	CL
	1 1/4	—	DX	DH	M42 X 2	—	DL
	1 1/2	—	—	FH	M48 X 2	—	FL
	—	1	XC	HC	—	M33 X 2	LC
	—	1 1/4	XD	HD	—	M42 X 2	LD
	—	1 1/2	—	HF	—	M48 X 2	LF
	Inlet —	Outlet 3/4	—	PW	Inlet —	Outlet —	—
	1	3/4	CT	CW	M33 X 2	M26 X 1.5	CZ
	1 1/4	3/4	DT	DW	M42 X 2	M26 X 1.5	DZ
	1 1/4	1	DC	DC	M42 X 2	M33 X 2	DN
	1 1/2	1	FC	FC	M48 X 2	M33 X 2	FN
	1 1/2	3/4	FW	FW	M48 X 2	M26 X 1.5	FZ
	Outlet 3/4	Inlet 1	MG	QG	M26 X 1.5	M33 X 2	TG
	3/4	1 1/4	MH	QH	M26 X 1.5	M42 X 2	TH
	1	1 1/4	NH	SH	M33 X 2	M42 X 2	VH
	1	1 1/2	—	SW	M33 X 2	M48 X 2	VW
	Inlet 1	Outlet 3/4	GM	GQ	M33 X 2	M26 X 1.5	GT
	1 1/4	3/4	HM	HQ	M42 X 2	M26 X 1.5	HT
	1 1/4	1	HN	HS	M42 X 2	M33 X 2	HV
	1 1/2	1	—	WS	M48 X 2	M33 X 2	VV
	Outlet 3/4	Inlet —	—	WP	Outlet —	Inlet —	—
	3/4	1	TC	WC	M26 X 1.5	M33 X 2	ZC
	3/4	1 1/4	TD	WD	M26 X 1.5	M42 X 2	ZD
	1	1 1/4	VD	CD	M33 X 2	M42 X 2	ND
	1	1 1/2	—	CF	M33 X 2	M48 X 2	NF
	3/4	1 1/2	—	WF	M26 X 1.5	M48 X 2	ZF
	Inlet 1	Outlet 3/4	PN	ST	Inlet M33 X 2	Outlet M26 X 1.5	KL
	Outlet 3/4	Inlet 1	NP	TS	Outlet M26 X 1.5	Inlet M33 X 2	LK
	1	1	EE*	RR*	M33 X 2	M33 X 2	KK*
	1 1/4	1 1/4	GG*	SS*	M42 X 2	M42 X 2	JJ*
	Inlet 1	Outlet 3/4	SX	PX	M33 X 2	M26 X 1.5	PV
	Outlet 3/4	Inlet 1	XS	XP	M26 X 1.5	M33 X 2	VP

* Code B, EE, RR, KK, GG, SS, and JJ for motors only.
Pump applications must be approved by Technical Service.



P31

Reliability

Series 31 and 30 pumps and motors are quite similar except that Series 31 units have steel alignment dowel pins which allow them to be rated for 500 psi higher pressure operation. Both are cast from hi-tensile gray iron and offer a wide variety of drive shafts designed for high torque input/output. Unique pressure balanced thrust plates contribute to operating efficiencies of over 90%.

These units are designed for continuous operation in heavy-duty implement circuits. They're equally at home on lift trucks, auto wreckers and small dump body applications.

Call our Component sales team for quick application assistance and pump specifications.

Performance Data

Performance data shown are the average results based on a series of laboratory tests of production units and are not necessarily representative of any one unit. Tests were run with the oil reservoir temperature at 120°F. Requests for more specific data should be directed to our sales representatives.

Performance data for pumps and motors having other gear widths can be approximated by multiplying values in tables below by actual gear width.

Pump Speed rpm	Avg. Output (gpm) @ 2000 psi Gear Width (inches)				
	1	1-1/4	1-1/2	1-3/4	2
900	6.5	8.0	10.0	12.0	13.5
1200	9.0	11.5	14.0	16.0	18.5
1500	11.5	14.5	17.5	20.5	23.5
2100	16.5	21.0	25.0	29.0	34.0

Motor Speed rpm	Avg. Input/Output (gpm) @ 2000 psi					
	1" gear		1-1/2" gear		2" gear	
	gpm	hp	gpm	hp	gpm	hp
800	9.0	8.5	13.0	13.0	17.0	17.5
1200	13.0	13.0	18.0	20.0	23.5	27.0
1600	16.0	17.5	23.0	26.0	30.5	35.0
2000	19.5	21.0	28.0	32.0	37.0	43.5

How To Specify and Code

This catalog contains codes for our most popular models. Complete codes for all configurations are readily available upon request.

Single Units

Full assembly codes for single units combine shaft end cover, port end cover, gear housing and drive shaft codes. They are preceded by the letter P or M for pump or motor — and by 31 to designate the series and model. An example of an assembly code follows:

M31 SINGLE MOTOR

Assembly Code: **M 31A 942 BE YF15-30**

- MotorM
- Series31
- ModelA
- 1. Shaft End Cover942
- 2. Port End CoverBE
- 3. Gear HousingYF15
- 4. Drive Shaft30

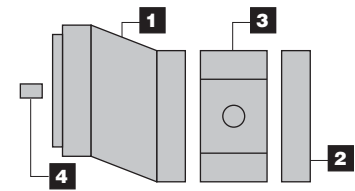

Multiple Units

Coding is the same as single units except that codes for added components must be included. Each gear unit added also requires code for a bearing carrier, the additional gear housing and connecting shaft. An example of an assembly code for a two-section Series 31 pump follows:

P31 MULTIPLE PUMP

Assembly Code: **P 31B 278 BY OM20-43 D UG10-1**

- PumpP
- Series31
- ModelB

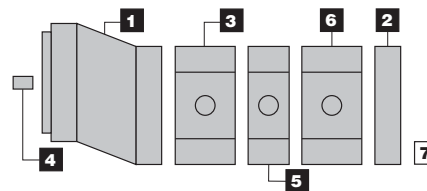

- 1. Shaft End Cover278
- 2. Port End CoverBY
- 3. Gear HousingOM20
- 4. Drive Shaft43
- 5. Bearing CoverD
- 6. Gear HousingUG10
- 7. Connecting Shaft1

Variations

Series 31 units are available with gear sections ranging from 1/2" to 2" in 1/4" increments which provide displacements from .985 to 3.94 cu. in. per revolution. Two or more gear sections can be assembled on one drive shaft to provide larger flows, supply other circuits or make smoother, more powerful motors.

When specifying multiple units you must consider the drive shaft's strength. This is called a PL factor in which P = operating pressure and L = sum of gear widths. The recommended PL factors for various Series 31 shafts are shown with the shaft codes and are offered as a guide to shaft selection. A PL of 8000 means a maximum of 4" of gear can be operated at 2000 psi (2000 psi X 4" = 8000) without overloading the shaft. The gear widths can be divided many ways, eg. (2"-1"-1", 1"-1"-1"-1", 1-1/2"-1-1/2"-1/2") to provide the output you need for several circuits.

P31 Parts Breakdown Typical Parts List

For Series P31 Seal Kits and Repair Parts, See Pages 475 - 477

Note:

This page shows the typical arrangement of a 2-section unit. It may not be pictorially correct and is not to scale.

Plug 5 in position B gives clockwise rotation.

Plug 5 in position A gives counter-clockwise rotation.

Check valves in both positions give bi-directional rotation.

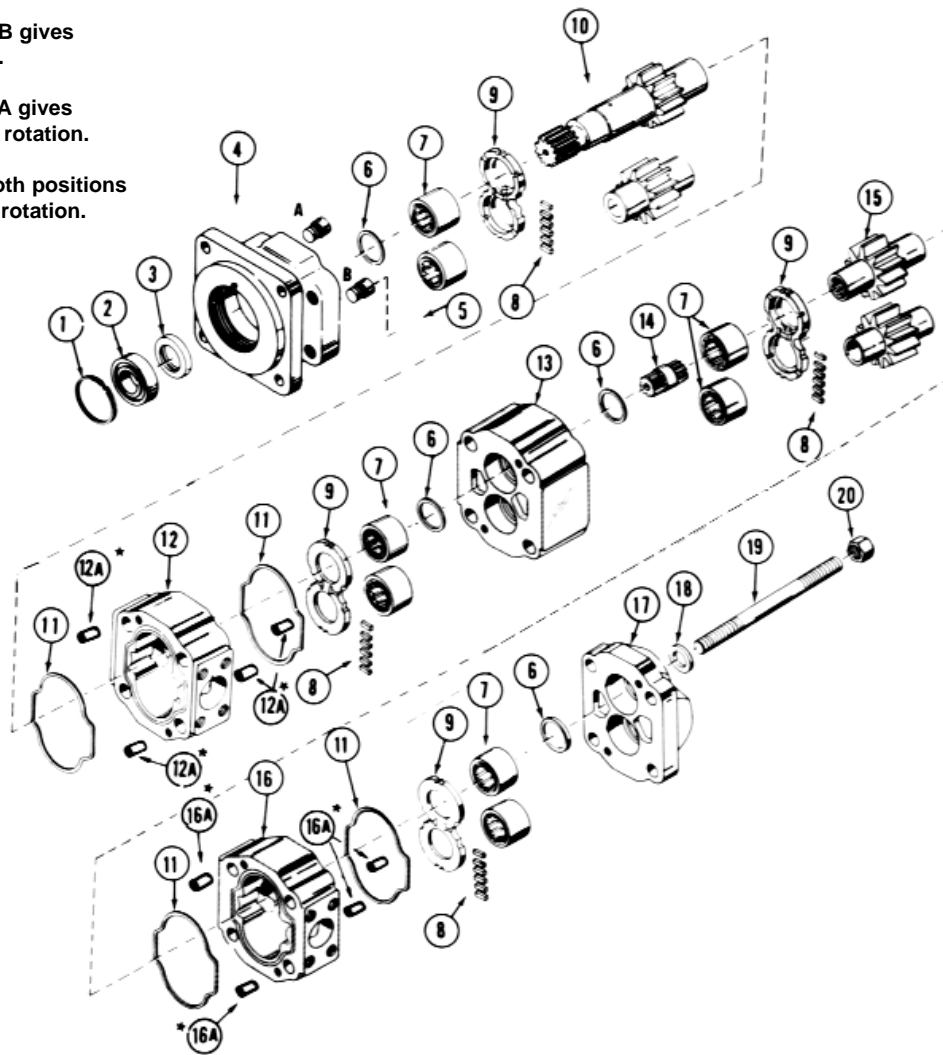

Item	Description	Part Number	Item	Description	Part Number
1	Snap Ring	CM-391-2686-063	11	Gasket Seals	CM-391-2884-050
2	Outboard Bearing	CM-391-0381-040	12	Gear Housing	See Option List
3	Seal (Pump)	CM-391-2883-058	12A	Dowel Pins	CM-391-2082-032
4	Hi Pressure Seal (Motor)	CM-391-2883-119	13	Bearing Carrier	See Option List
5	Shaft End Cover	See Option List	14	Connecting Shaft	See Option List
6	Check Assemblies	CM-391-3681-001	15	Matched Gear Set	See Option List
7	Plug	CM-391-2286-004	16	Gear Housing	See Option List
8	Ring Seals	CM-391-2585-006	16A	Dowel Pins	CM-391-2082-032
9	Roller Bearings	CM-391-0381-906	17	Port End Cover	See Option List
10	Pocket Seals	CM-391-2185-913	18	Washers	
11	Thrust Plates	See Option List	19	Studs or Cap Screws	
12	Integral Drive Shaft and Gear Set	See Option List	20	Nuts	

1 & 2 Shaft & Port End Covers

P31 SHAFT END COVERS

Description	Type	Outboard Bearing	PUMPS			MOTORS		
			CW	CCW	Double	1/4" NPT Drain	1/4" BSPP Drain	
Round Flange - 6 Bolt	1	Without	105	205		905	1905	
		With	405	505		805	1805	
SAE B - 4 Bolt	1	Without	142	242		942	1942	
		With	442	542		842	1842	
SAE C - 4 Bolt	1	Without	178	278		978	1978	
		With	478	578		878	1878	
SAE A - 2 Bolt	1	Without	194	294		994	1994	
		With	494	594		894	1894	
SAE B - 2 Bolt	1	Without	197	297		997	1997	
		With	497	597		897	1897	
Piggy Back Shaft End Cover	2	Without	196*	296*		N/A	N/A	
		50-30	Without	191	291		N/A	N/A
		30-30	Without	192	292		N/A	N/A
Pad Mounting	1	Without	N/A					
		With	400	500		800	1800	

Outboard bearing must be used with all drives subjected to radial loading. Helical gear drives must be approved through Technical Service.

* Available for special application upon request. Not a stock item.

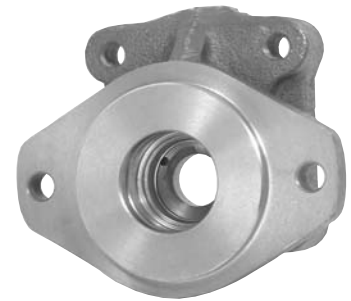

P31 PORT END COVERS

Description	Single Pumps	Multiple Pumps		Porting	
		w/Reg	w/2 Ext Studs	LH	RH
No Ports	BE	BI	BY	—	—
ODT Ports	CE*	CI	CY	3/4	—
	DE*	DI	DY	—	3/4
	FE*	FI	FY	3/4	3/4
	GE*	GI	GY	1	3/4
	HE	HI	HY	3/4	1
	JE*	JI*	JY*	1	1
BSPP Ports	WE	WI	WY	3/4	—
	XE	XI	XY	—	3/4
	ZE	ZI	ZY	3/4	3/4
Metric Straight Thread Ports	NE	NI	NY	M26 X 1.5	—
	PE	PI	PY	—	M26 X 1.5
	QE	QI	QY	M26 X 1.5	M26 X 1.5
	RE	RI	RY	M33 X 2	M26 X 1.5
	SE	SI	SY	M26 X 1.5	M33 X 2
Piggyback Port End Cover	Type	CW	CCW		
	31—31	KO	LO		

Priority Outlet see PB12-H2 for description of codes.

Available for special application upon request. Not a stock item.



3 & 6 Gear Housings



P31 GEAR HOUSINGS - BSPP PORTS

Porting		1/2	3/4	1	1 1/4	1 1/2	1 3/4	2
LH	RH							
—	—	AB05	AB07	AB10	AB12	AB15	AB17	AB20
3/4‡	—			YN10‡	YN12	YN15		
—	3/4‡			YQ10‡	YQ12	YQ15		YQ20
3/4	3/4			YS10*	YS12	YS15		YS20
3/4	1‡				YT12‡	YT15‡	YT17	
1‡	3/4			YV10‡*	YV12‡	YV15‡	YV17	YV20
3/4	1 1/4‡					YU15‡	YU17‡	
1 1/4‡	3/4						YW17‡	
1‡	—			SL10‡		SL15	SL17	
—	1					RQ15	RQ17	
1	1						MP17	MP20
1	1 1/4‡					VY15‡*	VY17‡	
1 1/4‡	1					IX15‡*		IX20‡
1	1 1/2‡						HW17‡	HW20‡
1 1/2‡	1						VI17‡	VI20‡
1 1/4‡	—							NJ20‡
—	1 1/4‡							UI20‡

*2500 PSI Maximum

P31 GEAR HOUSINGS - SAE STRAIGHT THREAD PORTS

Porting		1/2	3/4	1	1 1/4	1 1/2	1 3/4	2
LH	RH							
—	—	AB05	AB07	AB10	AB12	AB15	AB17	AB20
3/4‡	—			EC10‡	EC12	EC15	EC17	EC20
—	3/4‡			ED10‡	ED12	ED15	ED17	ED20
3/4	3/4				EF12	EF15	EF17	
3/4	1‡				EG12‡	EG15‡		
1‡	3/4				EJ12‡	EJ15‡		
3/4	1 1/4‡					EH15‡	EH17‡	
3/4	1 1/2‡							IN20‡
1 1/4‡	3/4					EK15‡	EK17‡	
1‡	—			AC10‡	AC12‡	AC15‡	AC17	AC20
—	1‡			AD10‡	AD12‡	AD15‡	AD17	AD20
1	1					AF15‡*	AF17	AF20
1	1 1/4‡					AG15‡*	AG17‡	AG20‡
1 1/4‡	1					AJ15‡*	AJ17‡	AJ20‡
1 1/4‡	—					AA15‡	AA17‡	
1	1 1/4‡					AO15‡	AO17‡	
1	1 1/2‡						AH17‡	AH20‡
1 1/2‡	1						AK17‡	AK20‡
1 1/2‡	—							AE20‡
—	1 1/2‡							AU20‡
1 1/4	1 1/4							AL20*
1 1/4	1 1/2‡							AM20*
1 1/2‡	1 1/4							AP20

* 2500 PSI Maximum

‡ Low Pressure Only

P31 GEAR HOUSINGS - SAE SPLIT FLANGE PORTS

Porting		1/2	3/4	1	1 1/4	1 1/2	1 3/4	2
LH	RH							
—	—	AB05	AB07	AB10	AB12	AB15	AB17	AB20
3/4	—			UC10	UC12	UC15		
—	3/4			UD10	UD12	UD15		
3/4	3/4			UF10	UF12	UF15		
3/4	1‡			UG10‡	UG12			
1‡	3/4			UJ10‡	UJ12			
3/4	1 1/4‡				UH12‡	UH15‡		
1 1/4‡	3/4				UK12‡	UK15‡		
1‡	—			OC10‡	OC12	OC15		
—	1‡			OD10‡	OD12	OD15		
1	1				OF12	OF15	OF17	OF20
1	1 1/4‡				OG12‡	OG15‡	OG17	OG20
1 1/4‡	1				OJ12‡	OJ15‡	OJ17	OJ20
1 1/4‡	—				OA12‡	OA15‡		
—	1 1/4‡				OB12‡	OB15‡		
1	1 1/2‡						OH17‡	OH20‡
1 1/2‡	1						OK17‡	OK20‡
1 1/4	1 1/4						OL17	OL20
1 1/4	1 1/2‡						OM17‡	OM20‡
1 1/2‡	1 1/4						OP17‡	OP20‡
1 1/2‡	—						OE17‡	OE20‡
—	1 1/2‡						OU17‡	OU20‡

‡ Low Pressure Only

P31 GEAR HOUSINGS - METRIC SPLIT FLANGE PORTS

Porting		1/2	3/4	1	1 1/4	1 1/2	1 3/4	2
LH	RH							
—	—	AB05	AB07	AB10	AB12	AB15	AB17	AB20
3/4	—			VN10	VN12			VN20
—	3/4			VQ10	VQ12			VQ20
3/4	3/4			VS10				
3/4	1‡			VT10‡	VT12			
1‡	3/4			RV10‡	RV12			
3/4	1 1/4‡				RU12‡	RU15‡		
1 1/4‡	3/4				RW12‡	RW15‡		
1‡	—			UL10‡	UL12	UL15		
—	1‡			UR10‡	UR12	UR15		
1	1				UM12	UM15	UM17	UM20
1	1 1/4‡				VU12‡	VU15‡	VU17	VU20
1 1/4‡	1				UX12‡	UX15‡	UX17	UX20
1	1 1/2‡						HO17‡	HO20‡
1 1/2‡	1						VO17‡	VO20‡
1 1/4‡	—				NO12‡	NO15‡		
—	1 1/4‡				UO12‡	UO15‡		
1 1/4	1 1/4						PO17	PO20
1 1/4	1 1/2‡						QO17‡	QO20‡
1 1/2‡	1 1/4						SO17‡	SO20‡
1 1/2‡	—						UY17‡	UY20‡
—	1 1/2‡						TO17‡	TO20‡

‡ Low Pressure Only

3 & 6 Gear Housings



P31 GEAR HOUSINGS - METRIC STRAIGHT THREAD PORTS

Porting		1/2	3/4	1	1 1/4	1 1/2	1 3/4	2
LH	RH	AB05	AB07	AB10	AB12	AB15	AB17	AB20
3/4‡	—			EN10‡	EN12			
—	3/4‡			TQ10‡	TQ12			
3/4	3/4			ES10*	ES12			
3/4	1‡				ET12‡	ET15‡		
1‡	3/4				EV12‡	EV15‡		
3/4	1 1/4‡					EU15‡		
1 1/4‡	3/4					EW15‡		
1‡	—					NL15‡		
—	1‡					ER15‡		
1	1					CM15‡		
1	1 1/4‡					VE15‡*		
1 1/4‡	1					EX15‡		
1	1 1/2‡						HA17‡	HA20‡
1 1/2‡	1						VA17‡	VA20‡

‡Low Pressure Only

* 2500 PSI Maximum

Port Size	Metric Straight Thread Size
3/4	M26 X 1.5
1	M33 X 2
1 1/4	M42 X 2
1 1/2	M48 X 2

P31 DRIVE SHAFTS

Shaft Description	Code		
	Type 1	Type 2	
SAE B - Straight Keyed .875" Diameter - 1/4" X 1" Key	30	—	
Standard - Straight Keyed .9998" Diameter - 1/4" X 1 1/4" Key	43	—	
SAE B - 13 Tooth Spline .873 Major Diameter	25	65*	
Standard - 6 Tooth Spline .997" Major Diameter	68*	—	
SAE A - 9 Tooth Spline .623" Major Diameter	95	—	
Connecting Shaft - Multiple Units	1	1	
Connecting Shaft - Piggyback Pump	P30 to P30	14	—
	P50 to P30	22	—
	P75 to P30	23	—

* Available for special application upon request. NOT A STOCK ITEM.

4 Drive Shafts









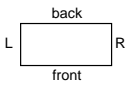

P31 DRIVE SHAFT CODE

GEAR WIDTH	1-14-22-23	25	30	43	65*	68*	95
1/2	•						
3/4	•	•	•	•			
1	•	•	•	•	•	•	•
1 1/4	•	•	•	•	•	•	•
1 1/2	•	•	•	•	•	•	
1 3/4	•	•	•	•	•	•	
2	•	•	•	•	•	•	

5 Bearing Carriers

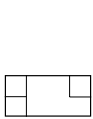
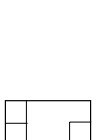

P31 BEARING CARRIERS (FLOW DIVIDERS ONLY)

	Ports		Ports		SAE Split Flge. Code	Metric Split Flge. Code	Ports		SAE Str. Thd. Code	Metric Str. Thd. Code	BSP Code
	Porting		Porting				Porting				
	LH	RH	LH	RH			LH	RH			
	—	—	—	—	B	B	—	—	B	B	B
	—	—	—	—	E	E	—	—	E	E	E
	1	—	1	—	J	T	1	—	F	—	X
	1 1/4	—	1 1/4	—	K	V	1 1/4	—	G	—	X
	1 1/2	—	1 1/2	—	L	W	1 1/2	—	H	—	Z
	—	—	—	—	—	—	M33 X 2	—	—	Q	—
	—	3/4	—	3/4	GR	TR	—	3/4	GJ	—	DG
	—	1	—	1	MT	FM	—	1	BK	—	DF
	—	—	—	—	—	—	—	M26 X 1.5	—	—	—
	—	—	—	—	—	—	—	M33 X 2	—	—	—
	—	3/4	—	3/4	FD	KT	—	3/4	JH	—	DM
	—	1	—	1	JG	RP	—	1	PC	—	MN
	—	—	—	—	—	—	—	M26 X 1.5	—	—	—
	—	—	—	—	—	—	—	M33 X 2	—	—	—
	1	3/4	1	3/4	HR	VR	1	3/4	HJ	—	FG
	1 1/4	3/4	1 1/4	3/4	PR	WR	1 1/4	3/4	MJ	—	SG
	1 1/2	3/4	1 1/2	3/4	QR	XR	1 1/2	3/4	RJ	—	XG
	1 1/4	1	1 1/4	1	NT	QM	1 1/4	1	PK	—	GF
	1 1/2	1	1 1/2	1	RT	VM	1 1/2	1	RK	—	MF
	—	—	—	—	—	—	M33 X 2	—	—	—	—
	—	—	—	—	—	—	M42 X 2	M26 X 1.5	—	—	—
	—	—	—	—	—	—	M48 X 2	M26 X 1.5	—	—	—
	—	—	—	—	—	—	M42 X 2	M26 X 1.5	—	—	—
	—	—	—	—	—	—	M48 X 2	M33 X 2	—	—	—
	1	3/4	1	3/4	GD	PT	1	3/4	PH	—	NM
	1 1/4	3/4	1 1/4	3/4	MD	QT	1 1/4	3/4	RH	—	PM
	1 1/2	3/4	1 1/2	3/4	PD	ZT	1 1/2	3/4	WH	—	TM
	1 1/4	1	1 1/4	1	PG	TP	1 1/4	1	QC	—	QN
	1 1/2	1	1 1/2	1	RG	ZP	1 1/2	1	VC	—	TN
	—	—	—	—	—	—	M33X 2	M26 X 1.5	—	—	—
	—	—	—	—	—	—	M42 X 2	M26 X 1.5	—	—	—
	—	—	—	—	—	—	M48 X 2	M26 X 1.5	—	—	—
	—	—	—	—	—	—	M42 X 2	M33 X 2	—	—	—
	—	—	—	—	—	—	M48 X 2	M33 X 2	—	—	—
	1	3/4	1	3/4	WL	FP	1	3/4	MC	—	HP
	—	—	—	—	—	—	M33 X 2	M26 X 1.5	—	—	—
	1	3/4	1	3/4	ZL	GP	1	3/4	SC	—	LP
	—	—	—	—	—	—	M33 X 2	M26 X 1.5	—	—	—



37X

Reliability

Commercial's pumps and motors have always been the most reliable, most efficient in the world. They're cast from high tensile iron for strength, machined precisely for efficiency, and carefully assembled and tested to assure long service life.

Call our Component sales team for quick application assistance and pump specifications.

Performance Data

Performance data shown are the average results based on a series of laboratory tests of production units and are not necessarily representative of any one unit. Tests were run with the oil reservoir temperature at 120°F. Requests for more specific data should be directed to our sales representatives.

Performance data for pumps and motors having other gear widths can be approximated by multiplying values in tables below by actual gear width.

Pump Speed rpm	Avg. Output (gpm) @ 2000 psi Gear Width (inches)			
	1	1-1/2	2	2-1/2
600	4.5	8.5	12.5	16.5
1200	12.5	20.0	28.0	35.5
1800	20.0	31.5	43.5	55.0
2100	24.0	37.5	51.0	64.5

Motor Speed rpm	Avg. Input/Output (gpm) @ 2000 psi					
	1" gear		2" gear		2-1/2" gear	
	gpm	hp	gpm	hp	gpm	hp
600	10.5	7.0	20.0	15.5	24.5	20.0
1000	16.0	12.0	31.0	26.0	38.0	34.5
1400	21.0	16.5	41.0	35.0	51.0	47.5
1800	26.5	20.0	52.0	45.0	64.0	60.0

How To Specify and Code

This catalog contains codes for our most popular models. Complete codes for all configurations are readily available upon request.

Single Units

Full assembly codes for single units combine shaft end cover, port end cover, gear housing and drive shaft codes. They are preceded by the letter P or M for pump or motor — and by 37X to designate the series and model. An example of an assembly code follows:

M37X SINGLE MOTOR

Assembly Code: **M 37X 942 BE 1T20 -25**

- MotorM
- Series37
- ModelX
- 1. Shaft End Cover942
- 2. Port End CoverBE
- 3. Gear Housing1T20
- 4. Drive Shaft25

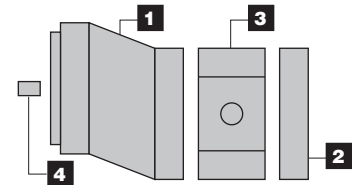

Multiple Units

Coding is the same as single units except that codes for added components must be included. Each gear unit added also requires code for a bearing carrier, the additional gear housing and connecting shaft. An example of an assembly code for a two-section Series 37X pump follows:

P37X MULTIPLE PUMP

Assembly Code: **P 37X 178BY VZ20-7 IL15-1**

- PumpP
- Series37
- ModelX

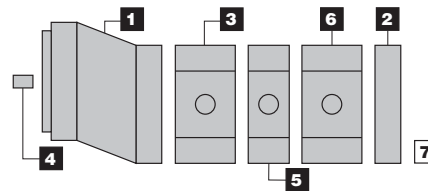

- 1. Shaft End Cover178
- 2. Port End CoverBY
- 3. Gear HousingVZ20
- 4. Drive Shaft7
- 5. Bearing CoverB
- 6. Gear HousingIL15
- 7. Connecting Shaft1

Variations

37X units are available with gear sections ranging from 1" to 2-1/2" in 1/4" increments. Two or more gear sections can be assembled on one drive shaft to provide larger flows, supply other circuits or make smoother, more powerful motors.

When specifying multiple units you must consider the drive shaft's strength. This is called a PL factor in which P = operating pressure and L = sum of gear widths. The recommended PL factors for various 37X shafts are shown with the shaft codes and are offered as a guide to shaft selection. A PL of 10000 means a maximum of 5" of gear can be operated at 2000 psi (2000 psi X 5" = 10000) without overloading the shaft. The gear widths can be divided many ways, eg. (2"-2"-1", 1"-1"-1"-1"-1", 1-1/2"-1-1/2"-2") to provide the output you need for several circuits.

37X Parts Breakdown Typical Parts List

For Series 37X Seal Kits and Repair Parts, See Pages 475 - 477

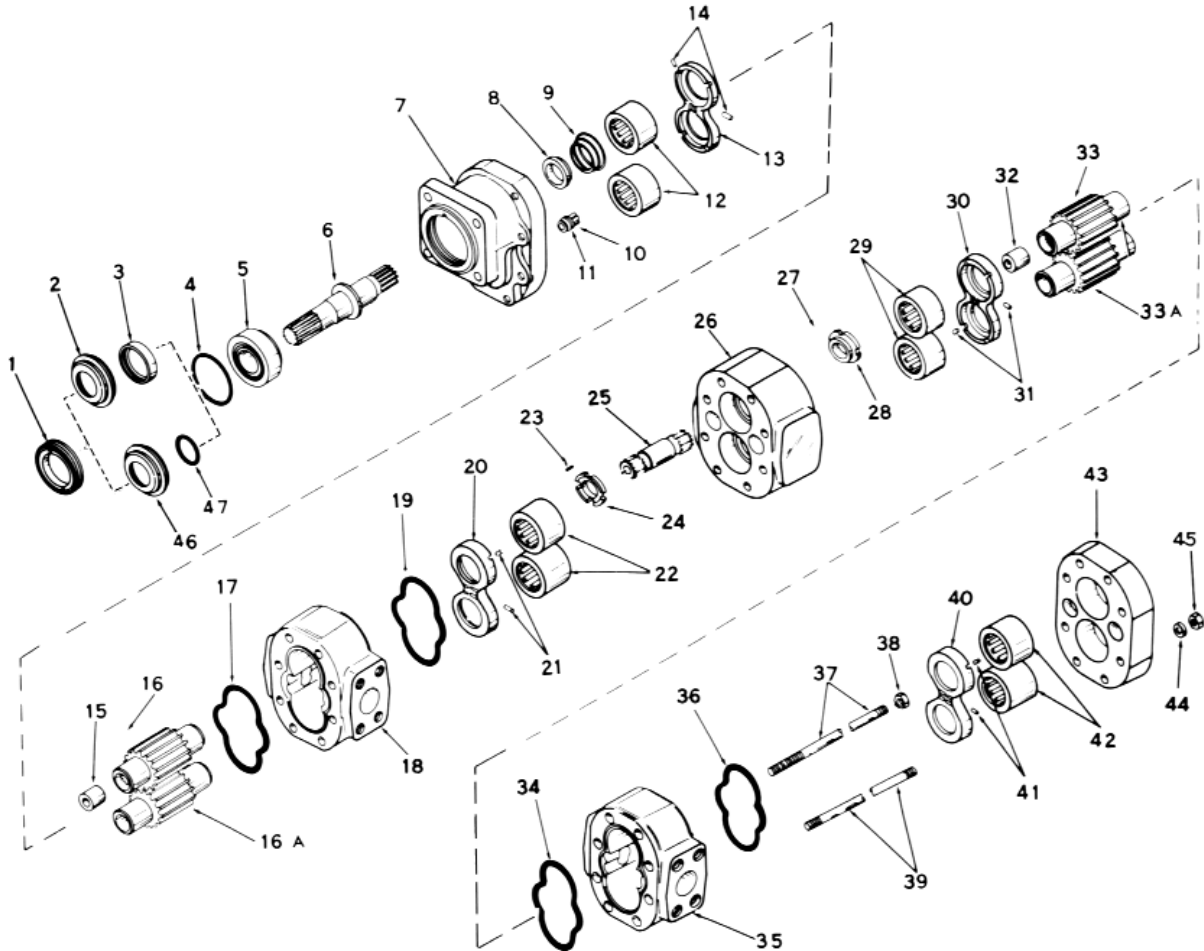

Item	Description	Part Number	Item	Description	Part Number
1	Retainer Ring	CM-391-2581-008	25	Connector Shaft	
2	Seal Retainer	CM-391-2548-015	26	Bearing Carrier	
3	Double Lip Seal (Shaft Seal-Pumps)	CM-391-2883-052	27	Roll pin	
4	"O" Ring	CM-391-2881-127	28	Shaft Bushing	CM-391-0481-004
5	Tapered Roller Bearing	CM-391-0384-006	29	Bearings	
6	Drive Shaft		30	Thrust Plate	
7	Shaft End Cover		31	Pocket Seal	
8	Shaft Bushing (Bronze)	CM-391-0481-001	32	Spacer	
9	Conical Spring	CM-391-3581-172	33	Matched Gears	
10	Set Screw		34	Gasket Seal	
11	Check Assemblies	CM-391-3681-001	35	Gear Housing	
12	Bearings		36	Gasket Seal	CM-391-2884-023
13	Thrust Plate		37	Connecting Stud	
14	Pocket Seals		38	Hex Head Nut	
15	Spacer		39	Studs	
16	Matched Gears		40	Thrust Plate	
17	Gasket Seal		41	Pocket Seals	
18	Gear Housing		42	Bearings	
19	Gasket Seal		43	Port End Cover	
20	Thrust Plate	CM-391-2185-909	44	Washer	
21	Pocket Seals		45	Hex Head Nut	
22	Bearing	CM-391-0381-904	46	Seal Retainer	CM-391-2581-004
23	Roll Pin		47	Hi Pressure Seal (shaft seal-motors)	CM-391-2883-094
24	Shaft Bushing				

1 & 2 Shaft & Port End Covers

37X SHAFT END COVERS

Description	SHAFT END COVERS					MOTORS	
	Type	PUMPS			No Drain	1/4" NPT	1/4" BSPP
		CW	CCW	Double		Drain	Drain
Pad Mounting	1	111	211	311	911	711	1711
Double Outboard Bearing	2			611		811	1811
SAE "B" 4 Bolt	1	142	242	342	942	742	1742
Double Outboard Bearing	2			642		842	1842
Special Flange	1	163	263	363	963		
Interchangeable with a Sundstrand Model 6" Dia B/C - 4 1/2 Pilot	Special						
SE "C" 4 Bolt	1	178	278	378	976	778	1778
Double Outboard Bearing	2	478	578	678		878	1878
6 Bolt Round Flange	1	181	281	381	981		
4 1/4 B/C Interchangeable with Vickers M-2400 Motor							
SAE "C" 2 Bolt	1	198	298	398	998	798	1798
Joy Only 4 Bolt	1	177	277	377			



37X PORT END COVERS

Description	Single	Multiple		Porting	
		w/o External Studs	w/External Studs	LH	RH
NPT Ports	BA	BU	BY	—	—
	CA	CU	CY	—	3/4
	DA	DU	DY	—	1
	FA	FU	FY	3/4	—
	GA	GU	GY	3/4	3/4
	HA	HU	HY	3/4	1
	JA	JU	JY	1	—
	KA	KU	KY	1	3/4
	LA	LU	LY	1	1
	ODT PORTS	—	—	—	—
—		—	—	1/2	—
—		—	—	1/2	1/2
NA		NU	NY	—	3/4
PA		PU	PY	3/4	—
MA		MU	MY	3/4	3/4



4 Gear & Shaft Combinations



37X GEAR AND SHAFT COMBINATIONS

Type I			
Description	Code Number	Description	Code Number
1.1247" Round Shaft	2-2	Standard SAE 14 Tooth	2-7
Straight Keyed 1/4 x 3/4 x 1 1/4'	5-2	Involute Spline - Type "C"	5-7
#51 P & W Key	7-2	1.2480" Major Dia	7-7
	10-2		10-7
	12-2		12-7
	15-2		15-7
	17-2		17-7
	20-2		20-7
	22-2		25-7
	25-2		30-7
	30-2		
6 Spline 1.1096" Dia	2-3	1.250" Round Shaft	2-8
2." Full Spline	5-3	1/4 x 3/8 x 1 3/4"	5-8
	7-3	#51 P & W Key	7-8
	10-3		10-8
	12-3		12-8
	15-3		15-8
	17-3		17-8
	20-3		20-8
	22-3		22-8
	25-3		25-8
	30-3		30-8
6 Spline 1.120" Dia	2-6	1.249" Dia Straight Key Shaft	2-11
1 13/16" to Shoulder	5-6	13/16 x 15/32 x 1 1/2"	5-11
	7-6	# 25 P & W Key	7-11
	10-6		10-11
	12-6		12-11
	15-6		15-11
	17-6		17-11
	20-6		20-11
	22-6		22-11
	25-6		25-11
	30-6		30-11
1.1235" Major Dia	2-10	SAE "B" 13 Tooth	2-25
6 Tooth Spine	5-10	Involute Spline	5-25
With Truarac Retaining Ring	7-10	.873" Maj. Dia.	7-25
	10-10		10-25
	12-10		12-25
	15-10		15-25
	17-10		17-25
	22-10		20-25
	25-10		22-25
	30-10		25-25
			30-25

Type II			
Description	Code Number	Description	Code Number
1.249" Dia Straight Shaft	2-73	1.250" Dia. SAE "C"	15-27
# 55 P & W Key	5-73	1"- 14 NS-2	17-27
1/2" - 13 NC Thread Tapped	7-73	Threaded End	20-27
3/4" Deep in Outboard End	10-73	# 25 P & W Key	22-27
For Double Bearing Shaft End	12-73	Special - Not Stocked	
Cover	15-73	6 Spline 1.120" Dia	2-77
	17-73	For Double Bearing Shaft	5-77
	20-73	End Cover	7-77
	22-73		10-77
	25-73		12-77
	30-73		15-77
1.0937" Dia Straight	2-79		17-77
Shaft 1" - 14 NF-2 Threaded	5-79		20-77
End For Double Bearing	7-79	Special - Not Stocked	22-77
Shaft End Cover	10-79		25-77
	12-79		
	15-79		
	17-79		
Special Not Stocked	20-79		
	22-79		
	25-79		
	30-79		

Connecting Shafts	
Description	Code Number
Connecting Shaft	2-1
	5-1
	7-1
	10-1
	12-1
	15-1
	17-1
	20-1
	22-1
	25-1
	30-1

3 & 6 Gear Housings

37X GEAR HOUSINGS - NPT PORTS

Porting											
LH	RH	1/2	3/4	1	1 1/4	1 1/2	1 3/4	2	2 1/4	2 1/2	3
—	—	AB05	AB07	AB10	AB12	AB15	AB17	AB20	AB22	AB25	AB30
1/2	1/2		EC07	EC10	EC12						
—	3/4		AF07	AF10	AF12	AF15	AF17				
3/4	—		AR07	AR10	AR12	AR15	AR17				
3/4	3/4		ER07	ER10	ER12	ER15	ER17	ER20	ER22	ER25	ER30
3/4	1			ET10	ET12	ET15	ET17	ET20	ET22	ET25	ET30
1	3/4			IJ10	IJ12	IJ15	IJ17	IJ20	IJ22	IJ25	IJ30
—	1			AH10	AH12	AH15	AH17	AH20	AH22	AH25	AH30
1	—			AT10	AT12	AT15	AT17	AT20	AT22	AT25	AT30
1	1			IL10	IL12	IL15	IL17	IL20	IL22	IL25	IL30
1	1 1/4					IM15	IM17	IM20	IM22	IM25	IM30
1 1/4	1					IS15	IS17	IS20	IS22	IS25	IS30
—	1 1/4					AJ15	AJ17	AJ20	AJ22	AJ25	AJ30
1 1/4	—					AV15	AV17	AV20	AV22	AV25	AV30
1 1/4	1 1/4					IT15	IT17	IT20	IT22	IT25	IT30
1 1/4	1 1/2							IU20	IU22	IU25	IU30
1 1/2	1 1/4							IZ20	IZ22	IZ25	IZ30
—	1 1/2								AK22	AK25	AK30
1 1/2	—								AW22	AW25	AW30
1 1/2	1 1/2							JC20	JC22	JC25	JC30
1	1 1/2							IN20	IN22	IN25	IN30
1 1/2	1							IY20	IY22	IY25	IY30
3/4	1 1/4					EU15	EU17	EU20	EU22	EU25	EU30
1 1/4	3/4					IQ15	IQ17	IQ20	IQ22	IQ25	IQ30



37X GEAR HOUSINGS - SAE STRAIGHT THREAD PORTS

Porting											
LH	RH	3/4	1	1 1/4	1 1/2	1 3/4	2	2 1/4	2 1/2	3	
—	—	AB07	AB10	AB12	AB15	AB17	AB20	AB22	AB25	AB30	
—	1/2	UC07	UC10	UC12	UC15						
1/2	—	UP07	UP10	UP12	UP15						
1/2	1/2	YC07	YC10	YC12	YC15						
1/2	3/4	YD07	YD10	YD12	YD15						
5/8	1/2	YJ07	YJ10	YJ12	YJ15						
—	5/8	UD07	UD10	UD12	UD15						
5/8	—	UQ07	UQ10	UQ12	UQ15						
5/8	5/8	YK07	YK10	YK12	YK15						
5/8	3/4		YL10	YL12	YL15	YL17					
3/4	5/8		YQ10	YQ12	YQ15	YQ17					
—	3/4		UF10	UF12	UF15	UF17					
3/4	—		UR10	UR12	UR15	UR17					
3/4	3/4		YR10	YR12	YR15	YR17	YR20	YR22	YR25	YR30	
3/4	7/8			YS12	YS15	YS17	YS20				
7/8	3/4		YX10	YX12	YX15	YX17	YX20				
—	7/8			UG12	UG15	UG17	UG20				
7/8	—			US12	US15	US17	US20				
7/8	7/8			YZ12	YZ15	YZ17	YZ20				
7/8	1				VC15	VC17	VC20	VC22	VC25		
1	7/8				VK15	VK17	VK20	VK22	VK25		
—	1		UH10		UH15	UH17	UH20	UH22	UH25		
1	—		UT10		UT15	UT17	UT20	UT22	UT25		
1	1			VL12	VL15	VL17	VL20	VL22	VL25		
1	1 1/4						VM20	VM22	VM25		
1 1/4	1						VS20	VS22	VS25		
—	1 1/4						UJ17	UJ20	UJ22	UJ25	
1 1/4	—						UV17	UV20	UV22	UV25	
1 1/4	1 1/4						VT17	VT20	VT22	VT25	VT30
1 1/4	1 1/2							VU20	VU22	VU25	VU30
1 1/2	1 1/4							VZ20	VZ22	VZ25	VZ30
—	1 1/2								UK25	UK30	
1 1/2	—								UW25	UW30	
1	3/4		VJ10	VJ12							
3/4	1		YT10	YT12							

37X GEAR HOUSINGS - SAE SPLIT FLANGE PORTS





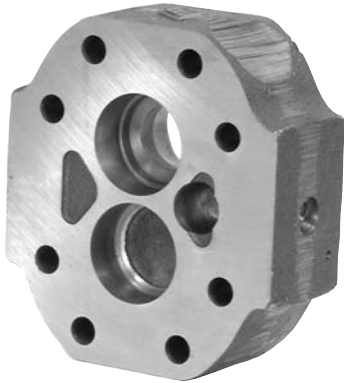

Porting											
LH	RH	3/4	1	1 1/4	1 1/2	1 3/4	2	2 1/4	2 1/2	3	
—	—	AB07	AB10	AB12	AB15	AB17	AB20	AB22	AB25	AB30	
3/4	—	OR07	OR10	OR12	OR15	OR17	OR20	OR22	OR25	OR30	
—	3/4	OF07	OF10	OF12	OF15	OF17	OF20	OF22	OF25	OF30	
3/4	1		ZT10	ZT12	ZT15	ZT17	ZT20	ZT22	ZT25	ZT30	
1	3/4		RJ10	RJ12	RJ15	RJ17	RJ20	RJ22	RJ25	RJ30	
—	1		OH10*	OH12	OH15	OH17	OH20	OH22	OH25	OH30	
1	—		OT10*	OT12	OT15	OT17	OT20	OT22	OT25	OT30	
1	1			RL12	RL15	RL17	RL20	RL22	RL25	RL30	
1	1 1/4			RM12	RM15	RM17	RM20	RM22	RM25	RM30	
1 1/4	1			RS12	RS15	RS17	RS20	RS22	RS25	RS30	
—	1 1/4				OJ15	OJ17	OJ20	OJ22	OJ25	OJ30	
1 1/4	—				OV15	OV17	OV20	OV22	OV25	OV30	
1 1/4	1 1/4				RT15	RT17	RT20	RT22	RT25	RT30	
1 1/4	1 1/2					RU17	RU20	RU22	RU25	RU30	
1 1/2	1 1/4					RZ12	RZ20	RZ22	RZ25	RZ30	
—	1 1/2					OK17*	OK20	OK22	OK25	OK30	
1 1/2	—					OW17*	OW20	OW22	OW25	OW30	
1 1/2	1 1/2						SC20	SC22	SC25	SC30	
1 1/2	2							SD22	SD25	SD30	
1/2	—	OP07	OP10	OP12	OP15	OP17	OP20	OP22	OP25	OP30	
—	1/2	OC07	OC10	OC12	OC15	OC17	OC20	OC22	OC25	OC30	
1/2	1/2	ZC07	ZC10	ZC12	ZC15	ZC17	ZC20	ZC22	ZC25	ZC30	
1/2	3/4	ZF07	ZF10	ZF12	ZF15	ZF17	ZF20	ZF22	ZF25	ZF30	
3/4	1/2	ZP07	ZP10	ZP12	ZP15	ZP17	ZP20	ZP22	ZP25	ZP30	
2	1 1/2							SH22	SH25	SH30	
—	2								OL25	OL30	
2	—								OX25	OX30	
2	2								SK25	SK30	
—	2 1/2									OM30	
2 1/2	—									OY30	
2 1/2	2 1/2									SO30	
2	1 1/4								SG25	SG30	
1 1/4	2								RX25	RX30	
1 1/2	2 1/2									SF30	
2 1/2	1 1/2									SN30	
3/4	3/4	ZR07	ZR10	ZR12	ZR15	ZR17	ZR20	ZR22	ZR25	ZR30	
3/4	1 1/4						ZU12	ZU15	ZU20	ZU30	
1 1/4	3/4				RQ15	RQ17	RQ20	RQ22	RQ25	RQ30	
1	1 1/2				RN15		RN20				
1 1/2	1				RY15		RY20				
2	1								OZ25		
1	2								OS25		

* Low pressure only
 † Low pressure inlet only

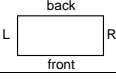
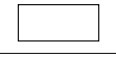
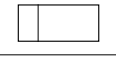
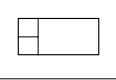
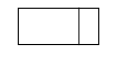
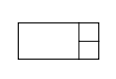
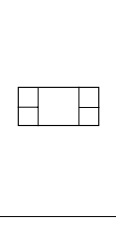
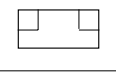
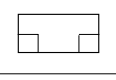
5 Bearing Carriers

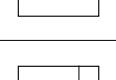

37X BEARING CARRIERS

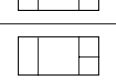
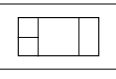
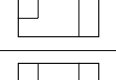
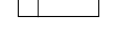
	Porting		NPT Parts Code	SAE Split Flange Code	SAE Straight Thread Code
	LH	RH			
	—	—	B		
	—	—	C		
	3/4 1 1 1/4 1 1/2	— — — —	D F G TL	FL FM FN FP	ND NF NG —
	—	—	H		
	— — —	3/4 1 1 1/4 1 1/2	J K L TJ	FO FR FS FT	— NJ NK —
	1 1 1/4 1 1/2 1 3/4 1 1/4 1 3/4 — 1 1/4	1 1 1/4 1 1/2 3/4 1 1 1/4 — 1 1/4 —	W BF TO R S X BB Q BC BD	GF GL GR FZ GB GG GH — GJ GK	NR NV — — — — — — NS NT
	3/4 1 1 1/4 1 1/2	3/4 1 1 1/4 1 1/2	DG DH DJ —	LN LP LQ LR	— QD QF —
	3/4 1 1 1/4 1 1/2	3/4 1 1 1/4 1 1/2	DK DL DM —	— LT LV —	— QH QJ —
	3/4 1 1 1/4	— — —	BS BX CD	— HQ —	PF PH —
	— — —	3/4 1 1 1/4 1 1/2	CG CL — —	KD KJ KN KS	— PP — —
	— — —	3/4 1 1 1/4	DV DW DX	MJ MK ML	QR QS QT
	3/4 1 1 1/4 1 1/2	— — — —	DZ FB FC —	MN MP — MR	— QW QX —
	3/4 1 1 1/4 1 1/2	3/4 1 1 1/4 1 1/2	DN DP DQ —	— LZ MB MC	— KQ QL —
	— —	— —	M	—	—
	— —	3/4 1	N T	— GC	NL —
	3/4 1 1 1/4	— — —	P V	— —	— —
	3/4 1 1 1/4	— — —	CS CX DD	KV LB LG	PT PW PZ
	— — —	3/4 1 1 1/4	BG BL —	— — —	NW — PC

37X BEARING CARRIERS

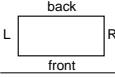
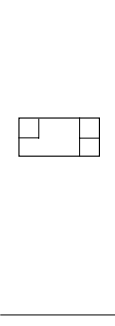
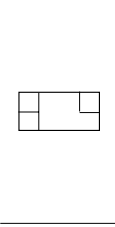
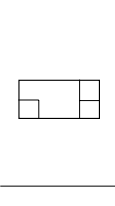
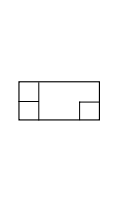
	Porting		NPT Parts Code	SAE Split Flange Code	SAE Straight Thread Code
	LH	RH			
	1 3/4 1 1/4 1 1 1 1/2 1 1/2 1 1/4 1 1/4 3/4 1 1 1/4 1 1/2 3/4 3/4 5/8	3/4 1 1 1 1/4 1 1/2 1 1 1/4 1 1/2 — 3/4 1 1 1/4 1 1/2 — 1 1/4 1	CV CW DB DC XT — — — — CT CZ DF — — — — —	— KZ LD LF XW — LJ LK KW LC — — LM XJ — — —	— — — — — PX — — — — BBJ BBK
	1 1 1/4 1 1 1/4 1 1/2 1 1/4 1 1/2 3/4 1 1 1/4	3/4 1 1 1/4 3/4 3/4 1 1/4 1 1/2 3/4 1 1 1/4	BJ BN BP XB XH — — — XS BH BM BR	GV HB HC — — HG HH — — GT — — —	— — — — — — — — NX PB PD
	3/4 1 1/4 1 1 3/4 3/4 1 1 1/4 1 1/2	1 1 1 1/4 1 1/2 1 1/4 3/4 1 1 1/4 1 1/2	BW CB CC TV TR BT BZ CF —	HP — HT TX — — — — — —	— — — — — — — — — —
	1 3/4 1 1/4 1 1 1/4 3/4 1 1 1/4 1 1/2 1 1/2	3/4 1 1 1/4 3/4 1 1 1/4 1 1/2 1 1/2	CJ CK CN CP XG CH CM CR — — — — — — —	KG KH KL KM — KF — — — — — — — — —	— — — — — — PQ — — — — — — — — —

P50



Reliability

Series 50 pumps and motors are cast from hi-tensile gray iron and offer a wide variety of drive shafts designed for high torque input/output. Unique pressure balanced thrust plates contribute to operating efficiencies of over 90%.

These units are designed for continuous operation in heavy-duty implement circuits. They're equally at home on lift trucks, auto wreckers and small dump body applications.

Call our Component sales team for quick application assistance and pump specifications.

Performance Data

Performance data shown are the average results based on a series of laboratory tests of production units and are not necessarily representative of any one unit. Tests were run with the oil reservoir temperature at 120°F. Requests for more specific data should be directed to our sales representatives.

Performance data for pumps and motors having other gear widths can be approximated by multiplying values in tables below by actual gear width.

Pump Speed rpm	Avg. Output (gpm) @ 2000 psi Gear Width (inches)			
	1	1-1/2	2	2-1/2
900	8.5	13.0	17.5	22.0
1200	12.0	18.0	24.0	30.0
1800	18.0	27.5	37.5	47.0
2100	21.5	32.5	44.0	55.0

Motor Speed rpm	Avg. Input/Output (gpm) @ 2000 psi					
	1" gear		2" gear		2-1/2" gear	
	gpm	hp	gpm	hp	gpm	hp
800	10.5	8.5	21.0	18.0	26.0	23.5
1200	15.5	13.0	30.5	27.5	37.5	35.0
1600	20.0	17.0	40.0	36.5	49.5	44.5
2000	25.0	21.0	49.0	44.5	61.5	54.5

Variations

Series 50 units are available with gear sections ranging from 1/2" to 2-1/2" in 1/4" increments which provide displacements from 1.27 to 6.37 cu. in. per revolution. Two or more gear sections can be assembled on one drive shaft to provide larger flows, supply other circuits or make smoother, more powerful motors.

When specifying multiple units you must consider the drive shaft's strength. This is called a PL factor in which P = operating pressure and L = sum of gear widths. The recommended PL factors for various Series 50 shafts are shown with the shaft codes and are offered as a guide to shaft selection. A PL of 8000 means a maximum of 4" of gear can be operated at 2000 psi (2000 psi X 4" = 8000) without overloading the shaft. The gear widths can be divided many ways, eg. (2"-1"-1", 1"-1"-1"-1", 1-1/2"-1-1/2"-1/2") to provide the output you need for several circuits.

How To Specify and Code

This catalog contains codes for our most popular models. Complete codes for all configurations are readily available upon request.

Single Units

Full assembly codes for single units combine shaft end cover, port end cover, gear housing and drive shaft codes. They are preceded by the letter P or M for pump or motor — and by 50 to designate the series and model. An example of an assembly code follows:

M50 SINGLE MOTOR

Assembly Code: **M 50A 942 BE YF15-7**

- MotorM
- Series50
- ModelA
- 1. Shaft End Cover942
- 2. Port End CoverBE
- 3. Gear HousingYF15
- 4. Drive Shaft7

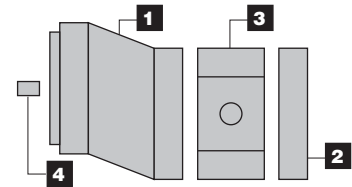

Multiple Units

Coding is the same as single units except that codes for added components must be included. Each gear unit added also requires code for a bearing carrier, the additional gear housing and connecting shaft. An example of an assembly code for a two-section Series 50 pump follows:

P50 MULTIPLE PUMP

Assembly Code: **P 50B 278 BY OM20-11 D UG10-1**

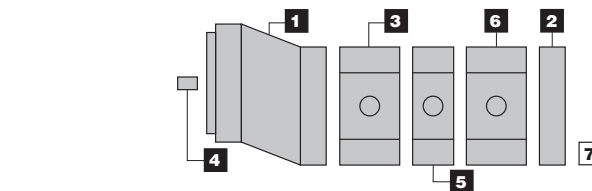

- PumpP
- Series50
- ModelB
- 1. Shaft End Cover278
- 2. Port End CoverBY
- 3. Gear HousingOM20
- 4. Drive Shaft11
- 5. Bearing CoverD
- 6. Gear HousingUG10
- 7. Connecting Shaft1

P50 Parts Breakdown Typical Parts List

For Series P50 Seal Kits and Repair Parts, See Pages 475 - 477

Note:

This page shows the typical arrangement of a 2-section unit. It may not be pictorially correct and is not to scale.

Plug 5 in position B gives clockwise rotation.

Plug 5 in position A gives counter-clockwise rotation.

Check valves in both positions give bi-directional rotation.

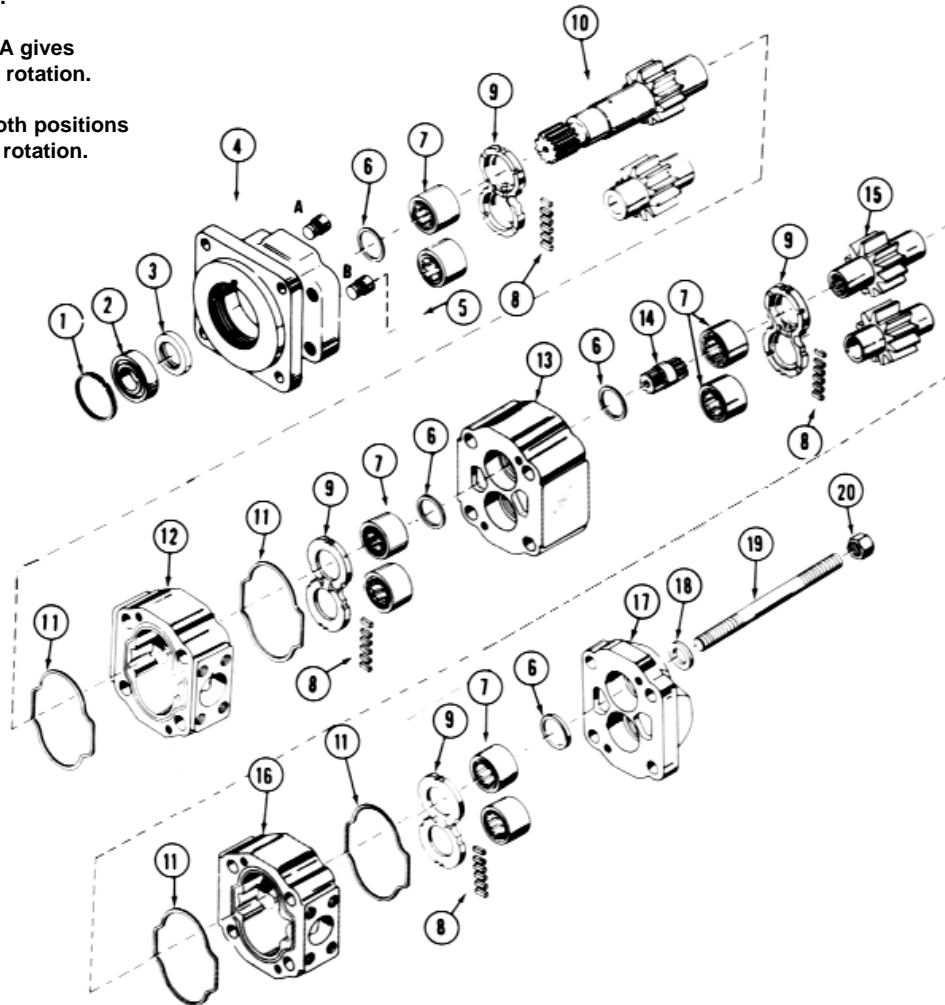

Item	Description	Part Number	Item	Description	Part Number
1	Snap Ring	CM-391-2686-065	10	Integral Drive Shaft and Gear Set	See Option List
2	Outboard Bearing	CM-391-0381-077	11	Gasket Seals	CM-391-2884-021
3	Seal (Pump)	CM-391-2883-103	12	Gear Housing	See Option List
	Hi Pressure Seal (Motor)	CM-391-2883-115	13	Bearing Carrier	See Option List
4	Shaft End Cover	See Option List	14	Connecting Shaft	See Option List
5	Check Assemblies	CM-391-3681-001	15	Matched Gear Set	See Option List
	Plug	CM-391-2286-004	16	Gear Housing	See Option List
6	Ring Seals	CM-391-2585-009	17	Port End Cover	See Option List
7	Roller Bearings	CM-391-0381-905	18	Washers	
8	Pocket Seals		19	Studs or Cap Screws	
9	Thrust Plates	CM-391-2185-912	20	Nuts	

1 & 2 Shaft & Port End Covers

P50 SHAFT END COVERS

Description	Type	Outboard Bearing	PUMPS			MOTORS	
			CW	CCW	Double	1/4" NPT DRAIN	1/4" BSPP DRAIN
SAE B 4 Bolt	1	Without	142	242	342	942	1942
		With	442	542	642	842	1842
SAE C 4 Bolt	1	Without	178	278	378	978	1978
		With	478	578	678	878	1878
SAE B 4 Bolt	1	Without	197	297	397	997	1997
		With	497	597	697	897	1897
SAE C 2 Bolt	2	Without	196*	296*	396*	N/A	N/A
		With	498	598	698	898	1898
Pad Mounting	1	Without	199	299	399	N/A	N/A
		With	400	500	600	800	1800
Piggyback Shaft End Cover	50-50 75-50	Without	191	291	391	N/A	N/A
		With	192	292	392	N/A	N/A

Two (2) speed motor valve assemble and fittings
 * Available for special application upon request. Not a stock item.



P50 PORT END COVERS

Description	Single Pumps	Multiple Pumps		Porting	
		w/o Studs	w/ Ext Studs	LH	RH
NPT Ports	BE	BI	BY	—	—
	*KE	KI	KY	3/4	—
	*LE	LI	LY	—	3/4
	*ME	MI	MY	3/4	3/4
ODT Ports	*CE	CI	CY	3/4	—
	*DE	DI	DY	—	3/4
	*FE	FI	FY	3/4	3/4
BSPP Ports	WE	WI	WY	3/4	—
	XE	XI	XY	—	3/4
	ZE	ZI	ZY	3/4	3/4
Metric Straight Thread Ports	NE	NI	NY	3/4	—
	PE	PI	PY	M26X1.5	3/4
	QE	QI	QY	3/4	M26X1.5
				M26X1.5	M26X1.5
Piggyback Port End Cover	Type	CW	CCW	Double	—
	50 — 50 50 — 30	KO	LO	MO	—
		KO	LO	MO	—

* Available for special application upon request. Not a stock item.



P50 DRIVE SHAFTS

Shaft Description	Code	
	Type 1	Type 2
Straight Keyed	43*	—
.998" Major Dia - 1/4 x 3/8" Key		
SAE B - 13 Tooth Spline	25*	—
.8730" Major Dia*		
SAE C - Straight Keyed	11	—
1.250" Major Dia - 5/16 x 1 1/2" Key		
SAE C - 14 Tooth Spline	7	53*
1.248" Major Diam.		
Connecting Shaft - Multiple Units	1	1
Connecting Shaft - Piggyback Pump	P50 to P50	22
	P75 to P50	23

* Available for special application upon request. NOT A STOCK ITEM.

4 Drive Shafts



P50 DRIVE SHAFT CODE

Gear Width	1-22-23	7	11	25*	43*	53*
1/2	•					
3/4	•					
1	•	•	•	•	•	•
1 1/4	•	•	•	•	•	•
1 1/2	•	•	•	•	•	•
1 3/4	•	•	•	•	•	•
2	•	•	•	•	•	•
2 1/4	•	•	•	•	•	•
2 1/2	•	•	•	•	•	•

3 & 6 Gear Housings

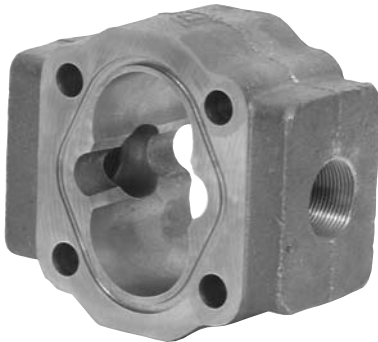

P50 GEAR HOUSINGS - NPT PORTS

Table with columns: Porting (LH, RH), 1/2, 3/4, 1, 1 1/4, 1 1/2, 1 3/4, 2, 2 1/4, 2 1/2. Lists various port configurations for NPT ports.

‡ Low pressure only.

P50 GEAR HOUSINGS - SAE SPLIT FLANGE PORTS

Table with columns: Porting (LH, RH), 1/2, 3/4, 1, 1 1/4, 1 1/2, 1 3/4, 2, 2 1/4, 2 1/2. Lists various port configurations for SAE split flange ports.

‡ Low pressure only. * 2000 PSI max.

P50 GEAR HOUSINGS - BSPP PORTS

Table with columns: Porting (LH, RH), 1/2, 3/4, 1, 1 1/4, 1 1/2, 1 3/4, 2, 2 1/4, 2 1/2. Lists various port configurations for BSPP ports.

‡ Low Pressure only. * 2000 PSI max.

P 50 GEAR HOUSINGS - SAE STRAIGHT THREAD PORTS

Table with columns: Porting (LH, RH), 1, 1 1/4, 1 1/2, 1 3/4, 2, 2 1/4, 2 1/2. Lists various port configurations for SAE straight thread ports.

‡ Low pressure only. * 2000 PSI max.

P50 GEAR HOUSINGS - METRIC SPLIT FLANGE PORTS

Table with columns: Porting (LH, RH), 1, 1 1/4, 1 1/2, 1 3/4, 2, 2 1/4, 2 1/2. Lists various port configurations for metric split flange ports.

‡ Low pressure only. * 2000 PSI max.



3 & 6 Gear Housings

P50 GEAR HOUSINGS - METRIC SPLIT FLANGE PORTS

Porting		1	1 1/4	1 1/2	1 3/4	2	2 1/4	2 1/2
LH	RH							
—	—	AB10	AB12	AB15	AB17	AB20	AB22	AB25
—	3/4	VQ10	VQ12	VQ15	VQ17			
3/4	1 1/4	VT10‡	VT12					
1 1/2	3/4	RV10‡	RV12‡	RV15	RV17	RV20		
3/4	1 1/4		RU12‡					
1 1/4	3/4		RW12‡					
—	1 1/2	UM12*	UM15	UM17	UM20	UM22		
1	1 1/4	VU12*	VU15					
1 1/4	1	UX12*	UX15‡	UX17‡	UX20	UX22	UX25	
1	1 1/2		HO15‡	HO17‡	HO20‡			
1 1/2	1		VI15‡	VO17‡	VO20‡			
1 1/4	—				NO20			
—	1 1/4			UO17‡	UO20	UO22	UO25	
1 1/4	1 1/4		PO15*	PO17*	PO20	PO22	PO25	
1 1/4	1 1/2		QO15‡	QO17*	QO20‡	QO22	QO25	
1 1/2	1 1/4		SO15‡*	SO17‡*	SO20‡*	SO22	SO25	
1 1/4	2‡				JR20‡	JR22‡	JR25‡	
2‡	1 1/4				JM20‡	JM22‡	JM25‡	
1 1/2	—		UY15‡	UY17‡		UT22		
—	1 1/2		TO15‡	TO17‡		TO22		
1 1/2	1 1/2				SV20*	SV22	SV25	
1 1/2	2‡				JN20‡*	JN22‡	JN25‡	
2‡	1 1/2				JQ20‡*	JQ22‡	JQ25‡	

‡ Low pressure only.
* 2000 PSI max.

P 50 GEAR HOUSINGS - METRIC STRAIGHT THREAD PORTS

Porting		1	1 1/4	1 1/2	1 3/4	2	2 1/4	2 1/2
LH	RH							
—	—	AB10	AB12	AB15	AB17	AB20	AB22	AB25
3/4‡	—	EN10‡						
—	3/4‡	TQ10‡	TQ12	TQ15	TQ17			
3/4	3/4	ES10*	ES12					
3/4	1 1/2	ET10*	ET12‡					
1 1/2	3/4	EV10*	EV12‡	EV15‡	EV17	EV20		
—	1 1/2			ER15‡	ER17	ER20	ER22	
1	1			CM15*	CM17	CM20		
1	1 1/4			VE15*	VE17‡			
1 1/4	1			EX15*	EX17‡	EX20‡	EX22	EX25
—	1 1/4					UA20‡	UA22	UA25
1 1/4	1 1/4					PA20*	PA22	PA25
1 1/4	1 1/2					QA20‡*	QA22‡	QA25
1 1/2	1 1/4					SA20‡*	SA22‡	SA25

‡ Low pressure only.
* 2000 PSI max.

Metric Straight Thread Size	Thread Size
3/4	M26 X 1.5
1	M33 X 2
1 1/4	M42 X 2
1 1/2	M48 X 2

P50 BEARING CARRIERS (FLOW DIVIDERS ONLY)

LH	Porting	RH	Ports					
			NPT Code	BSPP Code	SAE Split Flange Code	Metric Split Flange Code	SAE Std Thread Code	Metric Std Thread Code
—	—	—	B	B	B	B	B	B
—	—	—	E	E	E	E	E	E
1	—	—	M	X	J	T	F	—
1 1/4	—	—	N	Y	K	V	G	—
1 1/2	—	—	P	Z	L	W	H	—
M33 X 2	—	—	—	—	—	—	—	Q
M42 X 2	—	—	—	—	—	—	—	R
M48 X 2	—	—	—	—	—	—	—	S
—	3/4	—	BX	DG	GR	MT	GJ	—
M26 X 1.5	1	—	KZ	DF	TR	FM	BK	—
M33 X 2	—	—	—	—	—	—	—	QJ
—	3/4	—	CV	DM	FD	KT	JH	—
M26 X 1.5	1	—	NK	MN	JG	RP	PC	—
M33 X 2	—	—	—	—	—	—	—	BZ
—	—	—	—	—	—	—	—	MK
1	3/4	—	GX	FG	HR	VR	HJ	—
1 1/4	3/4	—	HX	SG	PR	WR	MJ	—
1 1/2	3/4	—	RX	XG	OR	XR	RJ	—
1 1/4	1	—	LZ	GF	NT	QM	PK	—
1 1/2	1	—	TZ	MF	RT	VM	RK	—
M48 X 2	M26 X 1.5	—	—	—	—	—	—	ZJ
M42 X 2	M33 X 2	—	—	—	—	—	—	PL
M48 X 2	M22 X 2	—	—	—	—	—	—	QL
M33 X 2	M26 X 1.5	—	—	—	—	—	—	SJ
M42 X 2	M26 X 1.5	—	—	—	—	—	—	XJ
1	3/4	—	GV	NM	GD	PT	PH	—
1 1/4	3/4	—	MV	PM	MD	QT	RH	—
1 1/2	3/4	—	NV	TM	PD	ZT	WH	—
1 1/4	1	—	TK	QN	PG	TP	QC	—
1 1/2	1	—	ZK	TN	RG	ZP	VC	—
M48 X 2	M26 X 1.5	—	—	—	—	—	—	YZ
M42 X 2	M33 X 2	—	—	—	—	—	—	OK
M48 X 2	M33 X 2	—	—	—	—	—	—	SK
M33 X 2	M26 X 1.5	—	—	—	—	—	—	PZ
M42 X 2	M26 X 1.5	—	—	—	—	—	—	QZ
1	3/4	—	VG	HP	WL	FP	MC	CP
1	3/4	—	WG	LP	ZL	GP	SC	DP







5 Bearing Carriers

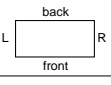

5 Bearing Carriers

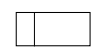

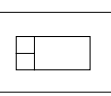
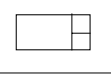
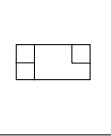
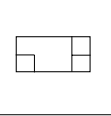
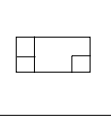
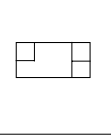
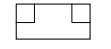

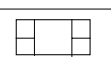
P50 BEARING CARRIERS (PUMPS ONLY)

L  R	Porting		BSPP Code	Metric Split Flange Code	Porting		Metric Straight Thread Code
	LH	RH			LH	RH	
	—	—	B	—	—	—	—
	—	—	C	—	—	—	—
	—	—	D	—	—	—	—
	Inlet 1 1 1/4 1 1/2	—	CX DX FX	CH DH FH	Inlet M33 X 2 M42 X 2 M48 X 2	—	CL DL FL
	—	Inlet 1 1 1/4 1 1/2	XC XD XF	HC HD HF	—	Inlet M33 X 2 M42 X 2 M48 X 2	LC LD LF
	Inlet — 1 1 1/4 1 1/4 1 1/2 1 1/2	Outlet 3/4 3/4 3/4 1 1 3/4	LT CT DT DV FV FT	PW CW DW DC FC FW	Inlet — M33 X 2 M42 X 2 M42 X 2 M48 X 2 M48 X 2	Outlet — M26 X 1.5 M26 X 1.5 M33 X 2 M33 X 2 M26 X 1.5	— CZ DZ DN FN FZ
	Outlet 3/4 3/4 3/4 1 1 1	Inlet 1 1/2 1 1 1/4 1 1/4 1 1/2	MW MG MH NH NW	QW QG QH SH SW	Outlet M26 X 1.5 M26 X 1.5 M26 X 1.5 M33 X 2 M33 X 2	Inlet M48 X 2 M33 X 2 M42 X 2 M42 X 2 M48 X 2	TW TG TH VH VW
	Inlet 1 1 1/4 1 1/4 1 1/2 1 1/2	Outlet 3/4 3/4 1 3/4 1	GM HM HN WM WN	GQ HQ HS WQ WS	Inlet M33 X 2 M42 X 2 M42 X 2 M48 X 2 M48 X 2	Outlet M26 X 1.5 M26 X 1.5 M33 X 2 M26 X 1.5 M33 X 2	GT HT HV WT WV
	Outlet 3/4 3/4 3/4 1 1 1 3/4	Inlet — 1 1 1/4 1 1/4 1 1/2 1 1/2	TL TC TD VD VF TF	WP WC WD CD CF WF	Outlet — M26 X 1.5 M26 X 1.5 M33 X 2 M33 X 2 M33 X 2 M26 X 1.5	Inlet — M33 X 2 M42 X 2 M42 X 2 M48 X 2 M48 X 2	— ZC ZD ND NF ZF
	Inlet 1	Outlet 3/4	PN	ST	Inlet M33 X 2	Outlet M26 X 1.5	KL
	Outlet 3/4	Inlet 1	NP	TS	Outlet M26 X 1.5	Inlet M33 X 2	LK
	1 1 1/4 1 1/2	1 1 1/4 1 1/2	EE* GG*	RR* SS* XX*	M33 X 2 M42 X 2	M33 X 2 M42 X 2	KK* JJ

* Code B, EE, RR, KK, GG, SS, and, XX for motors only. Pump applications must be approved by Technical Service.

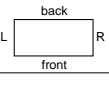
P50 BEARING CARRIERS (PUMPS ONLY)

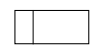
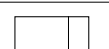
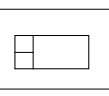
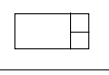
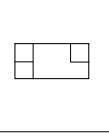
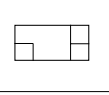
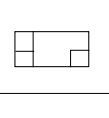
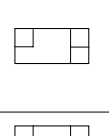
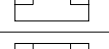
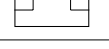
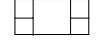
L  R	Porting		NPT Ports Code	SAE Split Flange Code	SAE Straight Thread Code
	LH	RH			
	—	—	B*	—	—
	—	—	C	—	—
	—	—	D	—	—
	Inlet 1 1 1/4 1 1/2	—	TB VB WB	LB MB NB	CB DB FB
	—	Inlet 1 1 1/4 1 1/2	BT BV BW	BL BM BN	BC BD BF
	Inlet 1 1 1/4 1 1/4 1 1/2 1 1/2	Outlet 3/4 3/4 1 1 3/4	TX VX VZ WZ WX	LR MR MS NS NR	CJ DJ DK FK FJ
	Outlet 3/4 3/4 1 1	Inlet 1 1 1/4 1 1/4 1 1/2	JT JV KV KW	XL XM ZM ZN	RC RD SD SF
	Inlet 1 1 1/4 1 1/4 1 1/2	Outlet 3/4 3/4 1 1	TJ VJ VK WK	LX MX MZ NZ	CR DR DS FS
	Outlet 3/4 3/4 3/4 1 1 1 3/4	Inlet — 1 1 1/4 1 1/4 1 1/2 1 1/2	XQ XT XV ZV ZW XW	RB RL RM SM SN RN	— JC JD KD KF JF
	Inlet 1	Outlet 3/4	ZX	SR	KJ
	Outlet 3/4	Inlet 1	XZ	RS	JK
	1 1 1/4 1 1/2	1 1 1/4 1 1/2	TT* VV* WW*	LL* MM* NN*	CC* BB* FF*

* Code B, TT, LL, CC, VV, MM, BB, WW, NN, and FF for motors only. Pump applications must be approved by Technical Services.

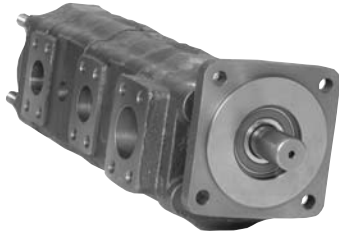

P51

Reliability

Series 51 and 50 pumps and motors are quite similar except that Series 51 units have steel alignment dowel pins which allow them to be rated for 500 psi higher pressure operation. Both are cast from hi-tensile gray iron and offer a wide variety of drive shafts designed for high torque input/output. Unique pressure balanced thrust plates contribute to operating efficiencies of over 90%.

These units are designed for continuous operation in heavy-duty implement circuits. They're equally at home on lift trucks, auto wreckers and small dump body applications.

Call our Component sales team for quick application assistance and pump specifications.

Performance Data

Performance data shown are the average results based on a series of laboratory tests of production units and are not necessarily representative of any one unit. Tests were run with the oil reservoir temperature at 120°F. Requests for more specific data should be directed to our sales representatives.

Performance data for pumps and motors having other gear widths can be approximated by multiplying values in tables below by actual gear width.

Pump Speed rpm	Avg. Output (gpm) @ 2000 psi Gear Width (inches)			
	1	1-1/2	2	2-1/2
900	8.5	13.0	17.5	22.0
1200	12.0	18.0	24.0	30.0
1800	18.0	27.5	37.5	47.0
2100	21.5	32.5	44.0	55.0

Motor Speed rpm	Avg. Input/Output (gpm) @ 2000 psi					
	1" gear		2" gear		2-1/2" gear	
	gpm	hp	gpm	hp	gpm	hp
800	10.5	10.5	21.0	23.0	26.0	29.5
1200	15.5	16.0	30.5	35.0	35.0	44.5
1600	20.0	21.0	40.0	46.0	49.5	58.5
2000	25.0	25.5	49.0	56.0	61.5	71.5

Variations

Series 51 units are available with gear sections ranging from 1/2" to 2-1/2" in 1/4" increments which provide displacements from 1.27 to 6.37 cu. in. per revolution. Two or more gear sections can be assembled on one drive shaft to provide larger flows, supply other circuits or make smoother, more powerful motors.

When specifying multiple units you must consider the drive shaft's strength. This is called a PL factor in which P = operating pressure and L = sum of gear widths. The recommended PL factors for various Series 51 shafts are shown with the shaft codes and are offered as a guide to shaft selection. A PL of 8000 means a maximum of 4" of gear can be operated at 2000 psi (2000 psi X 4" = 8000) without overloading the shaft. The gear widths can be divided many ways, eg. (2"-1"-1", 1"-1"-1"-1", 1-1/2"-1-1/2"-1/2") to provide the output you need for several circuits.

How To Specify and Code

This catalog contains codes for our most popular models. Complete codes for all configurations are readily available upon request.

Single Units

Full assembly codes for single units combine shaft end cover, port end cover, gear housing and drive shaft codes. They are preceded by the letter P or M for pump or motor — and by 51 to designate the series and model. An example of an assembly code follows:

M51 SINGLE MOTOR

Assembly Code: **M 51A 942 BE YF15-7**

- MotorM
- Series51
- ModelA
- 1. Shaft End Cover942
- 2. Port End CoverBE
- 3. Gear HousingYF15
- 4. Drive Shaft7

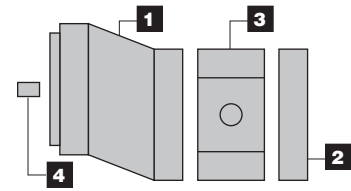

Multiple Units

Coding is the same as single units except that codes for added components must be included. Each gear unit added also requires code for a bearing carrier, the additional gear housing and connecting shaft. An example of an assembly code for a two-section Series 51 pump follows:

P51 MULTIPLE PUMP

Assembly Code: **P 51B 278 BY OM20-11 D UG10-1**

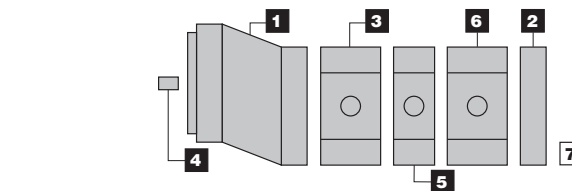

- PumpP
- Series51
- ModelB
- 1. Shaft End Cover278
- 2. Port End CoverBY
- 3. Gear HousingOM20
- 4. Drive Shaft11
- 5. Bearing CoverD
- 6. Gear HousingUG10
- 7. Connecting Shaft1

P51 Parts Breakdown Typical Parts List

For Series P51 Seal Kits and Repair Parts, See Pages 475 - 477

Note:

This page shows the typical arrangement of a 2-section unit. It may not be pictorially correct and is not to scale.

Plug 5 in position B gives clockwise rotation.

Plug 5 in position A gives counter-clockwise rotation.

Check valves in both positions give bi-directional rotation.

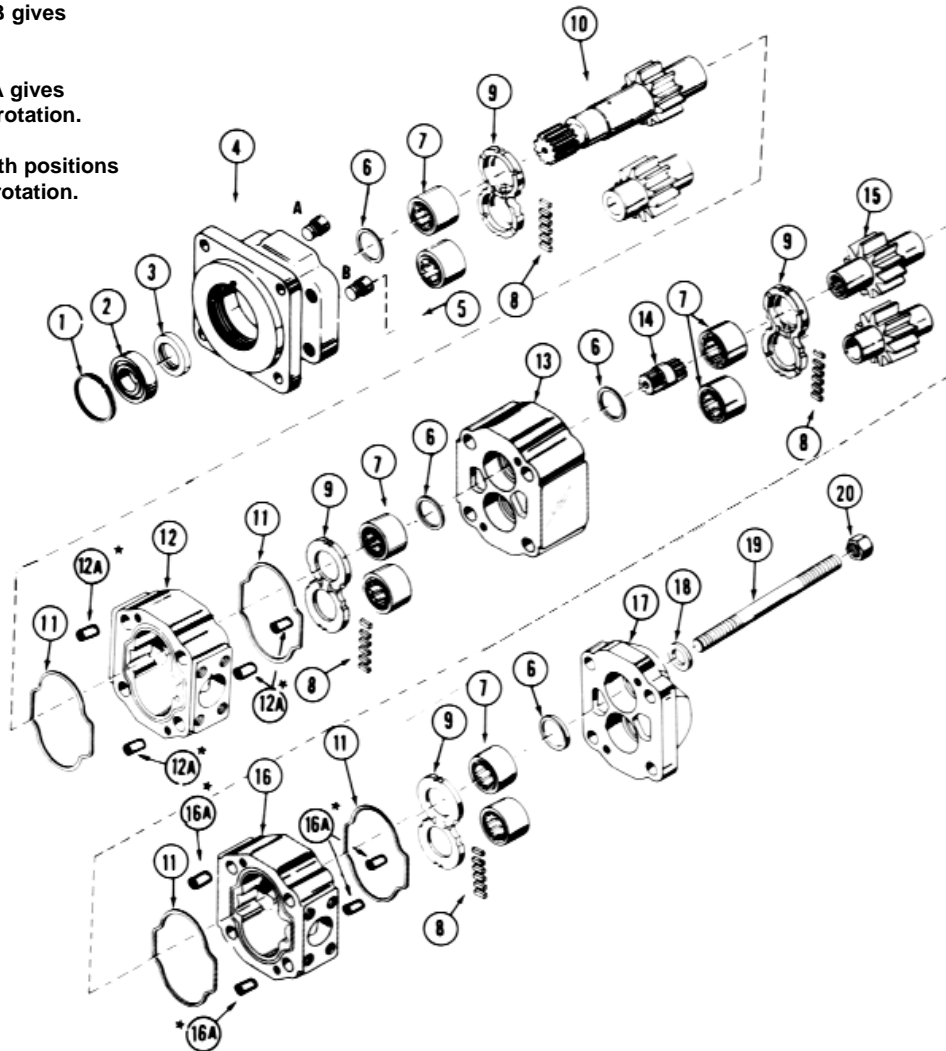

Item	Description	Part Number	Item	Description	Part Number
1	Snap Ring	CM-391-2686-065	11	Gasket Seals	CM-391-2884-021
2	Outboard Bearing	CM-391-0381-077	12	Gear Housing	See Option List
3	Seal	CM-391-2883-103	12A	Dowel Pins	CM-391-2082-032
4	Hi Pressure Seal (Motor)	CM-391-2883-115	13	Bearing Carrier	See Option List
5	Shaft End Cover	See Option List	14	Connecting Shaft	See Option List
5	Check Assemblies	CM-391-3681-001	15	Matched Gear Set	See Option List
	Plug	CM-391-2286-004	16	Gear Housing	See Option List
6	Ring Seals	CM-391-2585-009	16A	Dowel Pins	CM-391-2082-032
7	Roller Bearings	CM-391-0381-905	17	Port End Cover	See Option List
8	Pocket Seals		18	Washers	
9	Thrust Plates	CM-391-2185-912	19	Studs or Cap Screws	
10	Integral Drive Shaft and Gear Set	See Option List	20	Nuts	

1 & 2 Shaft & Port End Covers

P 51 SHAFT END COVERS

Description	PUMPS					MOTORS	
	Type	Outboard Bearing	CW	CCW	Double	1/4" NPT DRAIN	1/4" BSPP DRAIN
SAE B 4 Bolt	1	Without	142	242	342	942	1942
		With	442	542	642	842	1842
SAE C 4 Bolt	1	Without	178	278	378	978	1978
		With	478	578	678	878	1878
SAE B 2 Bolt	1	Without	197	297	397	997	1997
		With	497	597	697	897	1897
SAE C 2 Bolt	2	Without	196*	296*	396*	N/A	N/A
		With	198	298	398	998	1998
Pad Mounting	1	Without	198	298	398	998	1998
		With	498	598	698	898	1898
Piggyback Shaft End Cover	2	Without	199	299	399	N/A	N/A
		With	N/A	N/A	N/A	N/A	N/A
Piggyback Shaft End Cover	1	Without	N/A	N/A	N/A	N/A	N/A
		With	400	500	600	800	1800
Piggyback Shaft End Cover	50-50	Without	191	291	391	N/A	N/A
		With	192	292	392	N/A	N/A

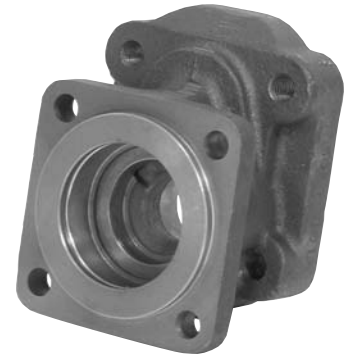

Two (2) speed motor valve assemble and fittings

* Available for special application upon request. Not a stock item.

P51 PORT END COVERS

Description	Single Pumps	Multiple Pumps		Porting	
		w/o Studs	w/ Ext Studs	LH	RH
No Ports	BE	BI	BY	—	—
ODT Ports	CE*	CI	CY	3/4	—
	DE*	DI	DY	—	3/4
	FE*	FI	FY	3/4	3/4
BSPP Ports	WE	WI	WY	3/4	—
	XE	XI	XY	—	3/4
	ZE	ZI	ZY	3/4	3/4
Metric Straight Thread Ports	NE	NI	NY	3/4	—
	PE	PI	PY	M26 X 1.5	—
				—	3/4
	QE	QI	QY	3/4	M26 X 1.5
M26 X 1.5				M26 X 1.5	
Piggyback Port End Cover	TYPE	CW	CCW	DOUBLE	—
	51—51	KO	LO	MO	—
Piggyback Port End Cover	51—31	KO	LO	MO	—



*Available for special application upon request. Not a stock item.

4 Drive Shafts



P51 DRIVE SHAFTS

Shaft Description	Code	
	Type 1	Type 2
Straight Keyed .998" Major Dia - 1/4 x 3/8" Key	43*	—
SAE B - 13 Tooth Spline .8555" Major Dia*	25*	—
SAE C - Straight Keyed 1.250" Major Dia - 3/4 x 1 1/2" Key	11	—
SAE C - 14 Tooth Spline 1.225" Major Diam.	7	53*
Connecting Shaft - Multiple Units	1	1
Connecting Shaft - Piggyback Pump	P51 to P51	22
	P76 to P51	23

* Available for special application upon request. NOT A STOCK ITEM.

P51 DRIVE SHAFT CODE

Gear Width	1-22-23	7	11	25*	43*	53*
1/2	•					
3/4	•					
1	•	•	•	•	•	•
1 1/4	•	•	•	•	•	•
1 1/2	•	•	•	•	•	•
1 3/4	•	•	•	•	•	•
2	•	•	•	•	•	•
2 1/4	•	•	•	•	•	•
2 1/2	•	•	•	•	•	•

3 & 6 Gear Housings



P51 GEAR HOUSINGS - BSPP PORTS

Porting		1/2	3/4	1	1 1/4	1 1/2	1 3/4	2	2 1/4	2 1/2
LH	RH									
—	—	AB05	AB07	AB10	AB12	AB15	AB17	AB20	AB22	AB25
3/4‡	—			YN10‡	YN12					
—	3/4‡			YQ10‡	YQ12‡	YQ15‡	YQ17	YQ20		
3/4	3/4				YS12	YS15		YS20		
3/4	1‡				YT12‡					
1‡	—				SL12‡	SL15‡				
1‡	3/4				YV12	YV15	YV17‡	YV20‡		
—	1‡			RQ10‡		RQ15‡	RQ17‡	RQ20‡	RQ22	RQ25
1	1							MP20		MP25
1	1 1/4‡							VY20‡		
1 1/4	1							IX20‡	IX22	IX25
—	1 1/4								UI22	UI25
1 1/4	1 1/4								PF22	PF25
1 1/2‡	1							VI20‡		
1 1/4	1 1/2‡									IQ25‡
1 1/2‡	1 1/4									IS25‡

‡ Low pressure only.



3 & 6 Gear Housings

P51 GEAR HOUSINGS - O.D. TUBE PORTS

Porting		1	1 1/4	1 1/2	1 3/4	2	2 1/4	2 1/2
LH	RH							
—	—	AB10	AB12	AB15	AB17	AB20	AB22	AB25
3/4‡	—	EC10‡	EC12‡					
—	3/4‡	ED10‡	ED12‡					
3/4	3/4				EF17			
3/4	1‡			EG15‡				
3/4	1 1/4‡			EH15*	EH17‡			
1 1/4‡	3/4			EK15*	EK17‡			
1‡	—	AC10‡	AC12‡	AC15‡	AC17‡			
—	1‡	AD10‡	AD12‡	AD15‡	AD17‡			
1	1					AF20*		AF25
1	1 1/4					AG20*		
1 1/4	1					AJ20*		
1 1/4‡	—			AA15‡	AA17‡			
—	1 1/4‡			AO15‡	AO17‡			
1	1 1/2					AH20*		
1 1/2	1					AK20*		
1 1/4	1 1/4						AL22	AL25
1 1/4	1 1/2‡						AM22‡	AM25‡
1 1/2‡	1 1/4						AP22‡	AP25‡
1 1/2‡	—					AE20‡	AE22‡	AE25‡
—	1 1/2‡					AU20‡	AU22‡	AU25‡
1 1/2	1 1/2							AR25*

‡ Low pressure only.
* 2500 PSI maximum.

P51 GEAR HOUSINGS - SAE SPLIT FLANGE PORTS

Porting		1	1 1/4	1 1/2	1 3/4	2	2 1/4	2 1/2
LH	RH							
—	—	AB10	AB12	AB15	AB17	AB20	AB22	AB25
3/4	—	UC10*	UC12*					
—	3/4	UD10*	UD12					
3/4	3/4	UF10*	UF12					
3/4	1‡	UG10*	UG12‡	UG15				
1‡	3/4	UJ10*	UJ12‡					
3/4	1 1/4‡		UH12‡	UH15‡	UH17‡			
1 1/4‡	3/4		UK12‡	UK15‡	UK17‡			
1‡	—		OC12‡	OC15‡	OC17	OC20		
—	1‡		OD12‡	OD15‡	OD17	OD20		
1	1		OF15*	OF17	OF20	OF20	OF22	
1	1 1/4‡		OG12‡	OG15*	OG17‡	OG20‡		
1 1/4‡	1			OJ15*	OJ17‡	OJ20‡	OJ22	
1 1/4‡	—		OA12‡	OA15‡				
—	1 1/4‡		OB12‡	OB15‡				
1	1 1/2‡			OH15*	OH17‡	OH20‡	OH22	
1 1/2‡	1			OK15*	OK17‡	OK20‡	OK22	OK25
1 1/4	1 1/4					OL20*	OL22	OL25
1 1/4	1 1/2					OM20‡*	OM22	OM25
1 1/2	1 1/4					OP20‡*	OP22	OP25
1 1/2‡	—			OE15‡	OE17‡	OE20‡	OE22	
—	1 1/2‡			OU15‡	OU17‡			
1 1/4	2‡					ON20‡*	ON22‡	ON25‡
2‡	1 1/4					OQ20‡*	OQ22‡	OQ25‡
1 1/2	1 1/2						OR22	OR25
1 1/2	2‡						OS22‡	OS25‡
2‡	1 1/2						OV22‡	OV25‡

‡ Low pressure only.
* 2500 PSI maximum.

P51 GEAR HOUSINGS - METRIC SPLIT FLANGE PORTS

Porting		1	1 1/4	1 1/2	1 3/4	2	2 1/4	2 1/2
LH	RH							
—	—	AB10	AB12	AB15	AB17	AB20	AB22	AB25
3/4‡	—	VN10‡						
—	3/4‡	VQ10‡				VQ20		
3/4	3/4	VS10						
3/4	1‡	VT10*	VT12‡					
1‡	3/4	RV10*	RV12‡					
3/4	1 1/4‡		RU12‡	RU15‡				
1 1/4‡	3/4		RW12‡	RW15‡				
1‡	—		UL12‡	UL15‡	UL17	UL20		
—	1‡		UR12‡	UR15‡	UR17	UR20		
1	1			UM15*	UM17	UM20	UM22	
1	1 1/4‡			YU15*	YU17‡	YU20‡		
1 1/4‡	1			UX15*	UX17‡	UX20‡		
1	1 1/2‡			HO15*	HO17‡	HO20‡	HO22	
1 1/2‡	1			VO15*	VO17‡	VO20‡	VO22	
1 1/4‡	—			NO12‡	NO15‡	NO17		
—	1 1/4‡		UO12‡	UO15‡				
1 1/4	1 1/4					PO20*	PO22	PO25
1 1/4	1 1/2					QO20*	QO22	QO25
1 1/2	1 1/4					SO20*	SO22	SO25
2‡	1					JB20‡		
1 1/4	2‡					JR20*	JR22‡	JR25‡
2‡	1 1/4					JM20*	JM22‡	JM25‡
1 1/2‡	—			UY15	UY17‡	UY20‡		
—	1 1/2‡				TO17‡	TO20‡		
1 1/2	1 1/2						SV22	SV25
1 1/2	2‡						JN22‡	JN25‡
2‡	1 1/2						JQ22‡	JQ25‡

‡ Low pressure only.
* 2500 PSI maximum.

P51 GEAR HOUSINGS - METRIC STRAIGHT THREAD PORTS

Porting		1	1 1/4	1 1/2	1 3/4	2	2 1/4	2 1/2
LH	RH							
—	—	AB10	AB12	AB15	AB17	AB20	AB22	AB25
3/4‡	—	EN10‡						
—	3/4	TQ10‡	TQ12‡	TQ15‡	TQ17			
3/4	3/4		ES12*					
3/4	1		ET12*					
1‡	3/4		EV12‡*	EV15‡*	EV17‡	EV20‡		
—	1‡		ER15‡	ER17‡	ER20‡	ER22		
1	1			CM17*				
1	1 1/4			VE17*				
1 1/4	1			EX17*	EX20*	EX22	EX25	
—	1 1/4‡				UA20‡	UA22	UA25	
1 1/4	1 1/4					PA22	PA25	
1 1/4	1 1/2‡					QA22‡	QA25‡	
1 1/2‡	1 1/4					SA22‡	SA25‡	

‡ Low pressure only.
* 2500 PSI maximum.

Metric Straight Thread Size	Thread Size
3/4	M26 X 1.5
1	M33 X 2
1 1/4	M42 X 2
1 1/2	M48 X 2

5 Bearing Carriers

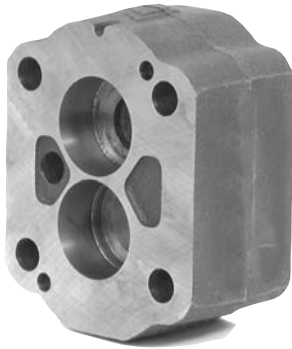

P51 BEARING CARRIERS (FLOW DIVIDERS ONLY)

L	Porting		BSPP Code	SAE Split Flange Code	Metric Split Flange Code	SAE Str. Thread Code	Metric Str. Thread Code
	LH	RH					
	—	—	B	B	B	B	B Motor
	—	—	E	E	E	E	E
	1	—	X	J	T	F	—
	1 1/4	—	Y	K	V	G	—
	1 1/2	—	Z	L	W	H	—
	M33 X 2	—	—	—	—	—	Q
	M42 X 2	—	—	—	—	—	R
	M48 X 2	—	—	—	—	—	S
	—	3/4	DG	GR	TR	GJ	—
	M26 X 1.5	1	DF	MT	FM	BK	—
	—	—	—	—	—	—	QJ
	M33 X 2	—	—	—	—	—	ML
	—	3/4	DM	FD	KT	JH	—
	M26 X 1.5	1	MN	JG	RP	PC	—
	—	—	—	—	—	—	BZ
	M33 X 2	—	—	—	—	—	MK
	1	3/4	FG	HR	VR	HJ	—
	1 1/4	3/4	SG	PR	WR	MJ	—
	1 1/3	3/4	XG	QR	XR	FJ	—
	1 1/4	1	GF	NT	OM	PK	—
	1 1/2	1	MF	RT	VM	PK	—
	M48 X 2	M26 X 1.5	—	—	—	—	ZJ
	M42 X 2	M33 X 2	—	—	—	—	PL
	M48 X 2	M33 X 2	—	—	—	—	QL
	M33 X 2	M26 X 1.5	—	—	—	—	SJ
	M42 X 2	M26 X 1.5	—	—	—	—	XJ
	1	3/4	NM	GD	PT	PH	—
	1 1/4	3/4	PM	MD	OT	RH	—
	1 1/2	3/4	TM	PD	ZT	WH	—
	1 1/4	1	QN	PG	TP	QC	—
1 1/2	1	TN	RG	ZP	VC	—	
	M48 X 2	M26 X 1.5	—	—	—	—	YZ
	M42 X 2	M33 X 2	—	—	—	—	OK
	M48 X 2	M33 X 2	—	—	—	—	SK
	M33 X 2	M26 X 1.5	—	—	—	—	PZ
	M42 X 2	M26 X 1.5	—	—	—	—	QZ
	1	3/4	HP	WL	FP	MC	—
	M33 X 2	M26 X 1.5	—	—	—	—	CP
	1	3/4	LP	ZL	GP	SX	—
	M33 X 2	M26 X 1.5	—	—	—	—	DP

P51 BEARING CARRIERS (PUMPS ONLY)

L	back	R	Porting		SAE Split Flange Code	SAE Straight Thread Code	Porting		BSPP Parts Code	Metric Split Flange Code	Porting		Metric Straight Thread
			LH	RH			LH	RH			LH	RH	
	—	—	—	—	B*	—	—	—	B*	—	—	—	—
	—	—	—	—	C OR A	—	—	—	C	—	—	—	—
	—	—	—	—	D OR U	—	—	—	D	—	—	—	—
	Inlet	—	—	—	LB	CBN	Inlet	—	CX	CH	Inlet	—	CL
	1 1/4	—	—	—	MB	DB	1 1/4	—	DX	DH	M33 X 2	—	DL
	1 1/2	—	—	—	NB	FB	1 1/2	—	FX	FH	M42 X 2	—	FL
	—	Inlet	—	—	BL	BC	—	Inlet	XC	HC	—	Inlet	LC
	—	1 1/4	—	—	BM	BD	—	1 1/4	XD	HD	—	M42 X 2	LD
	—	1 1/2	—	—	BN	BF	—	1 1/2	XF	HF	—	M48 X 2	LF
	Inlet	Outlet	—	—	LR	CJ	Inlet	Outlet	—	PW	Inlet	Outlet	—
	1	3/4	—	—	MR	DJ	1	3/4	CT	CW	M33 X 2	M26 X 1.5	CZ
	1 1/4	3/4	—	—	MS	DK	1 1/4	3/4	DT	DW	M42 X 2	M26 X 1.5	DZ
	1 1/2	1	—	—	NS	FK	1 1/4	1	DV	DC	M42 X 2	M33 X 2	DN
	1 1/2	3/4	—	—	NR	FJ	1 1/2	1	FV	FC	M48 X 2	M33 X 2	FN
	1 1/2	3/4	—	—	BR	FJ	1 1/2	3/4	FT	FW	M48 X 2	M26 X 1.5	FZ
	Outlet	Inlet	—	—	XL	RC	Outlet	Inlet	—	MW	Outlet	Inlet	—
	3/4	1	—	—	XM	RD	3/4	1 1/2	MG	OG	M26 X 1.5	M48 X 2	TW
	3/4	1 1/4	—	—	XN	RF	3/4	1	MH	OH	M26 X 1.5	M33 X 2	TG
	3/4	1 1/2	—	—	ZM	SD	1	1 1/4	NH	SH	M26 X 1.5	M42 X 2	TH
	1	1 1/4	—	—	ZN	SF	1	1 1/2	NW	SW	M33 X 2	M42 X 2	VH
	1	1 1/2	—	—	—	—	1	1 1/2	—	—	M33 X 2	M48 X 2	VW
	Inlet	Outlet	—	—	LX	CR	Inlet	Outlet	—	GM	Inlet	Outlet	—
	1	3/4	—	—	MX	DR	1 1/4	3/4	HM	HQ	M33 X 2	M26 X 1.5	GT
	1 1/4	3/4	—	—	MZ	DS	1 1/4	1	HN	HS	M42 X 2	M33 X 2	HT
	1 1/2	3/4	—	—	NX	FR	1 1/2	3/4	WM	WO	M42 X 2	M26 X 1.5	HV
	1 1/2	1	—	—	NZ	FS	1 1/2	1	WN	WS	M48 X 2	M33 X 2	WT
	1 1/2	1	—	—	—	—	1 1/2	1	—	—	M48 X 2	M33 X 2	WV
	Outlet	Inlet	—	—	RB	JP	Outlet	Inlet	—	TL	Outlet	Inlet	—
	3/4	1	—	—	RL	JC	3/4	1	TC	WC	M26 X 1.5	M33 X 2	ZC
	3/4	1 1/4	—	—	RM	KD	3/4	1 1/4	TD	WD	M26 X 1.5	M42 X 2	ZD
	1	1 1/4	—	—	SM	KS	1	1 1/4	VD	CD	M33 X 2	M42 X 2	ND
	1	1 1/2	—	—	SN	KF	1	1 1/2	VF	CF	M33 X 2	M48 X 2	NF
	3/4	1 1/2	—	—	RN	JF	3/4	1 1/2	TF	WF	M26 X 1.5	M48 X 2	ZF
	Inlet	Outlet	—	—	SR	KJ	Inlet	Outlet	—	PN	Inlet	Outlet	—
	1	3/4	—	—	—	—	1	3/4	—	—	M33 X 2	M26 X 1.5	KL
	Outlet	Inlet	—	—	RS	JK	Outlet	Inlet	—	NP	Outlet	Inlet	—
	3/4	1	—	—	—	—	3/4	1	—	—	M26 X 1.5	M33 X 2	LK
	1	1	—	—	LL*	OC*	1	1	EE*	RR*	M33 X 2	M33 X 2	KK*
	1 1/4	1 1/4	—	—	MM*	BB*	1 1/4	1 1/4	GG*	SS*	M42 X 2	M42 X 2	JJ
	1 1/2	1 1/2	—	—	NN*	FF*	—	—	—	—	—	—	—

* Code B, TT, LL, CC, VV, MM, BB, WW, NN, and FF for motors only.
 * Code B, EE, RR, KK, GG, and SS for motors only.
 Pump applications must be approved by Technical Service.

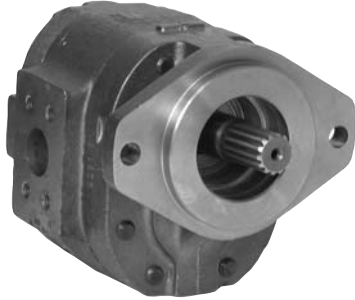

P75

Reliability

Series 75 pumps and motors are cast from hi-tensile gray iron and offer a wide variety of drive shafts designed for high torque input/output. Unique pressure balanced thrust plates contribute to operating efficiencies of over 90%.

These units are designed for continuous operation in heavy-duty implement circuits. They're equally at home on lift trucks, auto wreckers and small dump body applications.

Call our Component sales team for quick application assistance and pump specifications.

Performance Data

Performance data shown are the average results based on a series of laboratory tests of production units and are not necessarily representative of any one unit. Tests were run with the oil reservoir temperature at 120°F. Requests for more specific data should be directed to our sales representatives.

Performance data for pumps and motors having other gear widths can be approximated by multiplying values in tables below by actual gear width.

Pump Speed rpm	Avg. Output (gpm) @ 2000 psi Gear Width (inches)			
	1	1-1/2	2	2-1/2
600	6.0	11.5	16.5	21.0
1200	17.0	27.0	37.5	48.0
1800	22.0	35.5	48.0	61.0
2100	33.0	51.5	69.5	87.0

Motor Speed rpm	Avg. Input/Output (gpm) @ 2000 psi					
	1" gear		2" gear		2-1/2" gear	
rpm	gpm	hp	gpm	hp	gpm	hp
800	20.5	13.5	35.5	28.0	43.0	36.5
1200	27.5	19.5	49.5	42.0	60.5	54.0
1600	34.0	25.5	64.0	55.0	78.5	71.0
2000	41.5	30.0	78.0	67.5	96.5	87.0

How To Specify and Code

This catalog contains codes for our most popular models. Complete codes for all configurations are readily available upon request.

Single Units

Full assembly codes for single units combine shaft end cover, port end cover, gear housing and drive shaft codes. They are preceded by the letter P or M for pump or motor — and by 75 to designate the series and model. An example of an assembly code follows:

M75 SINGLE MOTOR

Assembly Code: **M 75A 942 BE YF15-7**

- MotorM
- Series75
- ModelA
- 1. Shaft End Cover942
- 2. Port End CoverBE
- 3. Gear HousingYF15
- 4. Drive Shaft7

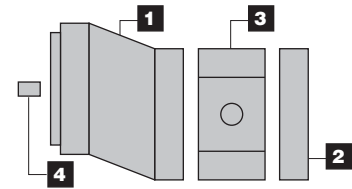

Multiple Units

Coding is the same as single units except that codes for added components must be included. Each gear unit added also requires code for a bearing carrier, the additional gear housing and connecting shaft. An example of an assembly code for a two-section Series 75 pump follows:

P75 MULTIPLE PUMP

Assembly Code: **P 75B 178 BI OK15-7 C OK12-1**

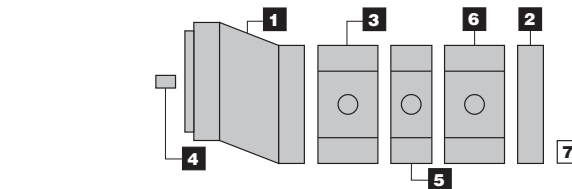

- PumpP
- Series75
- ModelB
- 1. Shaft End Cover178
- 2. Port End CoverBI
- 3. Gear HousingOK15
- 4. Drive Shaft7
- 5. Bearing CoverD
- 6. Gear HousingOK12
- 7. Connecting Shaft1

Variations

Series 75 units are available with gear sections ranging from 1/2" to 2-1/2" in 1/4" increments. Two or more gear sections can be assembled on one drive shaft to provide larger flows, supply other circuits or make smoother, more powerful motors.

When specifying multiple units you must consider the drive shaft's strength. This is called a PL factor in which P = operating pressure and L = sum of gear widths. The recommended PL factors for various Series 75 shafts are shown with the shaft codes and are offered as a guide to shaft selection. A PL of 8000 means a maximum of 4" of gear can be operated at 2000 psi (2000 psi X 4" = 8000) without overloading the shaft. The gear widths can be divided many ways, eg. (2"-1"-1", 1"-1"-1"-1", 1-1/2"-1-1/2"-1/2") to provide the output you need for several circuits.

P75 Parts Breakdown Typical Parts List

For Series P75 Seal Kits and Repair Parts, See Pages 475 - 477

Note:

Plug 7 in position B gives clockwise rotation.

Plug 7 in position A gives counter-clockwise rotation.

Check valves in both positions give bi-directional rotation.

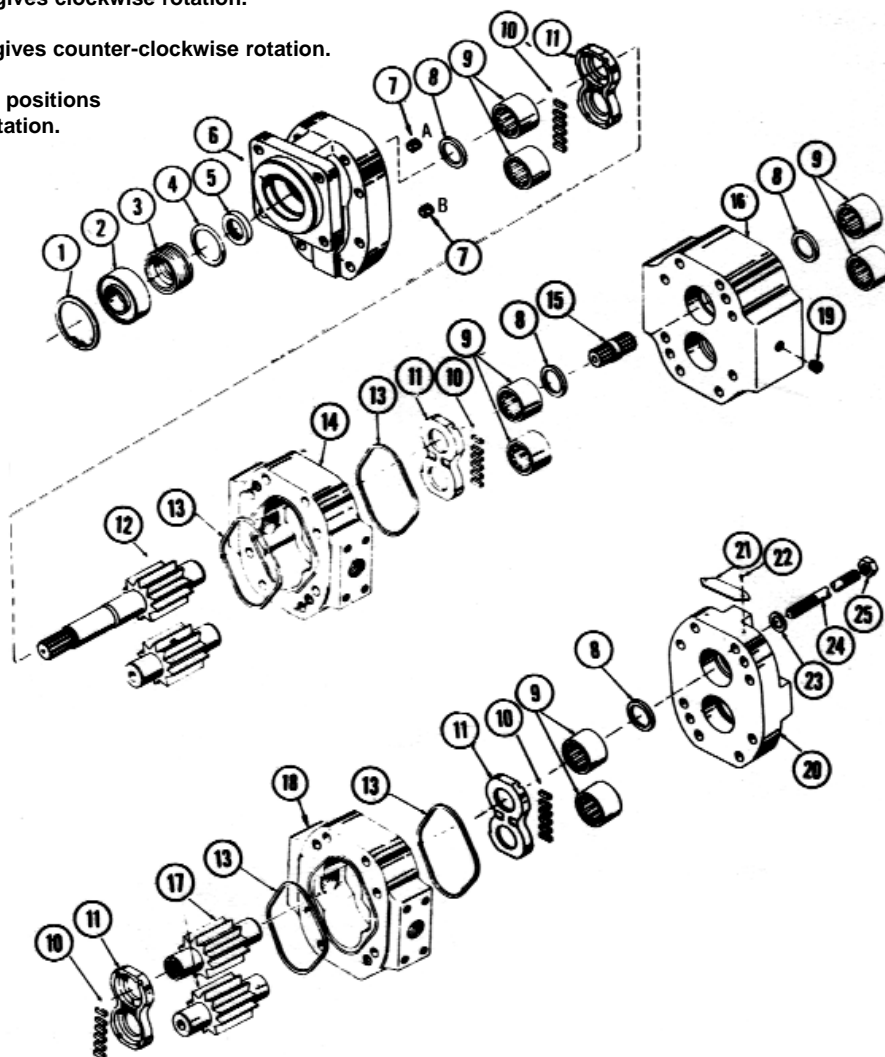

Item	Description	Part Number	Item	Description	Part Number
1	Snap Ring	CM-391-2686-025	12	Integral Drive Shaft and Gear Set	See Option List
2	Outboard Bearing	CM-391-0381-078	13	Gasket Seals	
3	Spacer	CM-391-3383-018	14	Gear Housing	See Option List
4	Seal Retainer	CM-391-2584-051	15	Connecting Shaft	See Option List
5	"O" Ring	CM-391-2881-457	16	Bearing Carrier	See Option List
6	Seal (Pump)	CM-391-2883-052	17	Matched Gear Set	See Option List
7	Seal (Motor)	CM-391-2883-094	18	Gear Housing	See Option List
8	Shaft End Cover		19	Plug	
9	Check Assemblies	CM-391-3681-001	20	Port End Cover	
10	Plug	CM-391-2286-004	21	Name Plate	
11	Ring Seals	CM-391-2585-011	22	Drive Screws	
12	Roller Bearings	CM-391-0381-904	23	Washers	
13	Pocket Seals	CM-391-2282-084	24	Studs or Cap Screws	
14	Thrust Plates	CM-391-2185-920	25	Nuts	

1 & 2 Shaft & Port End Covers

P75 SHAFT END COVERS - PORT END COVERS

Description	Outboard Bearing	PUMPS			MOTORS	
		CW	CCW	Double	1/4" NPT DRAIN	1/4" BSPP DRAIN
SAE D - 4 Bolt	Without	180	280	380	980	1980
	With	480	580	680	880	1880
SAE C - 2 Bolt	Without	198	298	398	998	1998
	With	498	598	698	898	1898
SAE B - 4 Bolt	Without	142	242	342	942	1942
	With	442	542	642	842	1842
SAE C - 4 Bolt	Without	178	278	378	978	1978
	With	478	578	678	878	1878

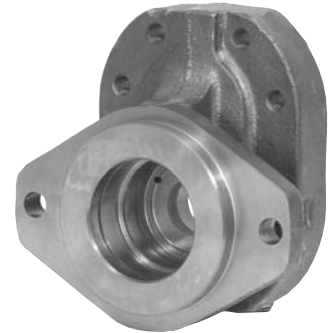

P75 PORT END COVERS

Description	Single Pumps	Multiple Pumps		Porting	
		w/o Studs	w/ Ext Studs	LH	RH
No Ports	BE	BI	BY	-	-
SAE Straight Thread	JE	JI	JY	1	1
Metric Straight Thread	TE	TI	TY	1	1
Piggyback Port End Covers	Type 75-50	CW KO	CCW LO	DUAL MO	
	75-30				



P75 GEAR & SHAFT COMBINATIONS

Shaft Description	Code	
	Type 1	Type 2
SAE C - 14 Tooth Spline - 1 5/16" Long For Single Units 1.2480" Major Dia.	7	—
SAE C - 14 Tooth Spline - 1 3/4" Spline For Multiple Units 1.2480" Major Dia.	7*(c)	—
SAE C - Straight (Shaft only) For P75C Models 1.250" Dia 5/16 x 1 1/2" Key	11*	1
Connecting Shaft - Multiple Units	1	1
Connecting Shaft - Piggyback Pump	23	—

4 Drive Shafts

P75 DRIVE SHAFT CODE				
Gear Width	1-23	7	7* (c)	11*
3/4	•	N/A	Same	•
1	•	•	as	•
1 1/4	•	•	Regular	•
1 1/2	•	•	Code 7	•
1 3/4	•	•		•
2	•	•		•
2 1/4	•	•		•
2 1/2	•	•		•
2 3/4	•	•		•
3	•	•		•

* Available for special application upon request. Not a stock item.



3 & 6 Gear Housings

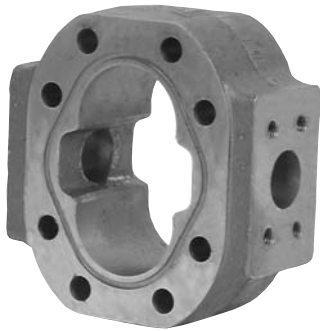

P75 GEAR HOUSINGS - BSPP PORTS

Porting		3/4	1	1 1/4	1 1/2	1 3/4	2	2 1/4	2 1/2	2 3/4	3
LH	RH										
—	—	AB07	AB10	AB12	AB15	AB17	AB20	AB22	AB25	AB27	AB30
—	3/4	YQ07	YQ10	YQ12	YQ15		YQ20				
3/4	1‡	YT07‡									
1‡	3/4	YV07‡	YV10	YV12	YV15		YV20				
1	—			SL12							
—	1			RQ12	RQ15	RQ17	RQ20		RQ25		
1	1		MP10*	MP12	MP15						
1	1 1/4‡		VY10‡*	VY12‡*							
1 1/4‡	1				IX15		IX20	IX22			IX30
1	1 1/2‡				HW15‡						
1 1/2	1				VI15‡	VI17‡					
—	1 1/4‡			UT12‡*							
1 1/4	1 1/4				PF15*	PF17*	PF20*		PF25		
1 1/2‡	1 1/4				IS15‡*	IS17‡*		IS22			

‡ Low pressure only.
* 2000 PSI maximum.

P75 GEAR HOUSINGS - NPT PORTS

Porting		3/4	1	1 1/4	1 1/2	1 3/4	2	2 1/4	2 1/2	2 3/4	3
LH	RH										
—	—	AB07	AB10	AB12	AB15	AB17	AB20	AB22	AB25	AB27	AB30
—	3/4	ID07	ID10	ID12	ID15						
3/4	1		IG10								
1	3/4		IJ10	IJ12	IJ15						
—	1			YD12	YD15						
1	1		YF10								
1	1 1/4			YG12	YG15						
1 1/4	1			YJ12	YJ15						
1 1/4	1 1/4			YL12	YL15	YL17					

P75 GEAR HOUSINGS - OD TUBE PORTS

Porting		3/4	1	1 1/4	1 1/2	1 3/4	2	2 1/4	2 1/2	2 3/4	3
LH	RH										
—	—	AB07	AB10	AB12	AB15	AB17	AB20	AB22	AB25	AB27	AB30
—	3/4	ED07	ED10	ED12	ED15						
—	1				AD12	AD15					
3/4	1‡	EG07‡									
3/4	1 1/4‡		EH10‡								
1‡	3/4	EJ07‡			EJ12	EJ15					
1	1		AF10*	AF12	AF15	AF17	AF20				
1	1 1/4‡		AG10‡*	AG12‡							
1	1 1/2‡				AH15‡						
1 1/4‡	3/4		EK10‡								
1 1/4	1 1/2‡				AM15‡*	AM17‡*					
1 1/2‡	1 1/4				AP15‡*	AP17‡*					
1 1/2	1 1/2					AR17					
1 1/4‡	1		AJ10‡*	AJ12‡							
1 1/2‡	1				AK15‡						
1 1/4	1 1/4				AL15*	AL17*				AL25	AL30

‡ Low pressure only.
* 2000 PSI maximum.

NOTE: AR17 must have Technical service approval.

3 & 6 Gear Housings

P75 GEAR HOUSINGS - SAE SPLIT FLANGE PORTS

Porting		3/4	1	1 1/4	1 1/2	1 3/4	2	2 1/4	2 1/2	2 3/4	3
LH	RH										
—	—	AB07	AB10	AB12	AB15	AB17	AB20	AB22	AB25	AB27	AB30
—	1 1/4			OB12	OB15	OB17	OB20	OB22	OB25		
—	1		OD10	OD12	OD15	OD17	OD20				
1	—			OC12							
—	3/4	UD07	UD10	UD12	UD15						
3/4	1	UG07	UG10								
1	3/4	UJ07	UJ10	UJ12	UJ15	UJ17	UJ20				
1	1		OF10	OF12	OF15	OF17	OF20		OF25	OF27	OF30
1	1 1/4‡		OG10‡	PG12	OG15						
1 1/4	—						OA20				
1 1/4‡	1		OJ10‡	OJ12	OJ15	OJ17	OJ20	OJ22	OJ25		
1 1/4	1 1/4		OL10*	UL12	OL15	OL17	OL20	OL22	OL25	OL27	OL30
1 1/2‡	1			OK12‡	OK15	OK17	OK20				
1	1 1/2‡			OH12‡	OH15	OH17	OH20				
1 1/4	1 1/2			OM12‡	OM15	OM17	OM20	OM22	OM25		
1 1/2‡	1 1/4			OP12‡	OP15	OP17	OP20	OP22	OP25	OP27	OP30
1 1/2	1 1/2				OR15*	OR17	OR20	OR22	OR25	OR27	OR30
1 1/2	2‡					ON17‡	ON20‡	ON22	ON25	ON27	ON30
2‡	1 1/4					OQ17‡	OQ20‡	OQ22	OQ25	OQ27	OQ30
1 1/2	2‡					OS17‡*	OS20‡	OS22	OS25	OS27	OS30
2‡	1 1/2					OV17‡*	OV20‡	OV22	OV25	OV27	OV30
2	2								OX25*	OX27	OX30
1 1/2	2 1/2‡								OT25‡	OT27‡	OT30‡
2 1/2‡	1 1/2								OW25‡	OW27‡	OW30‡
1 1/2	—						OE20	OE22			
—	1 1/2						OU20	OU22	OU25	OU27	OU30
2	2 1/2‡										OV30‡
2 1/2‡	2										OZ30‡
1 1/4	2 1/2‡								UN25‡		
2 1/2‡	1 1/4								US25‡		



‡ Low pressure only.
* 2000 PSI maximum.

P75 GEAR HOUSINGS - METRIC STRAIGHT THREAD PORTS

Porting		3/4	1	1 1/4	1 1/2	1 3/4	2	2 1/4	2 1/2	2 3/4	3
LH	RH										
—	—	AB07	AB10	AB12	AB15	AB17	AB20	AB22	AB25	AB27	AB30
—	3/4 M26 X 1.5	TQ07	TQ10	TQ12	TQ15						
—	1 M33 X 2			ER12	ER15						
3/4 M26 X 1.5	1‡ M33 X 2	ET07‡									
1‡ M33 X 2	3/4 M26 X 1.5	EV07‡		EV12	EV15						
1 M33 X 2	1 M33 X 2		CM10*	CM12	CM15						

‡ Low pressure only.
* 2000 PSI maximum.

3 & 6 Gear Housings



P75 GEAR HOUSINGS - METRIC SPLIT FLANGE PORTS





Porting		3/4	1	1 1/4	1 1/2	1 3/4	2	2 1/4	2 1/2	2 3/4	3
LH	RH										
—	—	AB07	AB10	AB12	AB15	AB17	AB20	AB22	AB25	AB27	AB30
—	3/4	VQ07	VQ10	VQ12	VQ15						
—	1		UR10	UR12	UR15	UR17	UR20				
—	1 1/4			UO12	UO15	UO17	UO20	UO22	UO25		
3/4	1	VT07	VT10								
1	3/4	RV07	RV10	RV12	RV15	RV17	RV20				
1	1		UM10	UM12	UM15	UM17	UM20				
1	1 1/4‡		VU10‡	VU12							
1 1/4‡	1		UX10‡	UX12	UX15	UX17	UX20	UX22	UX25		
1 1/4	1 1/4			PO12	PO15	PO17	PO20	PO22	PO25	PO27	PO30
1 1/2‡	1			VO12‡	VO15‡						
1	1 1/2‡			HO12‡	HO15‡						
1 1/4	1 1/2‡				QO15‡	QO17	QO20	QO22			
1 1/2‡	1 1/4				SO15‡	SO17	SO20	SO22	SO25	SO27	SO30
1 1/2	1 1/2					SV17*	SV20	SV22	SV25	SV27	SV30
1 1/4	2‡					JR17‡	JR20‡	JR22	JR25		
2‡	1 1/4					JM17‡	JM20‡	JM22	JM25		
1 1/2	2‡					JN17‡*	JN20‡	JN22	JN25	JN27	JN30
2‡	1 1/2					JQ17‡*	JQ20‡	JQ22	JQ25	JQ27	JQ30
2	2									JS27	JS30
1 1/2	2 1/2‡									JX27‡	JX30‡
2 1/2‡	1 1/2									LJ27‡	LJ30‡
1 1/2‡	—						UY20‡	UY22	UY25		
—	1 1/2‡						TO20‡	TO22	TO25	TO27	TO30

‡ Low pressure only.
* 2000 PSI maximum.

5 Bearing Carriers



P75 BEARING CARRIERS

	LH	RH	NPT Code	SAE Split Flange Code	ODT Code	BSPB Code	METRIC Split Flange Code	Str Thread Code
MOTORS								
	—	—	B			B		
	1 1 1/4 1 1/2	1 1 1/4 1 1/2	— — —	— MM NN	CC BB —	EE GG HH	RR SS XX	KK JJ ZZ
PUMPS								
	—	—	C			C		
	—	—	D			D		

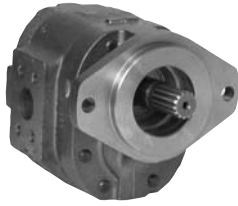

P76

Reliability

Series 76 and 75 pumps and motors are quite similar except that Series 76 units have steel alignment dowel pins which allow them to be rated for 500 psi higher pressure operation. Both are cast from hi-tensile gray iron and offer a wide variety of drive shafts designed for high torque input/output. Unique pressure balanced thrust plates contribute to operating efficiencies of over 90%.

These units are designed for continuous operation in heavy-duty implement circuits. They're equally at home on lift trucks, auto wreckers and small dump body applications.

Call our Component sales team for quick application assistance and pump specifications.

Performance Data

Performance data shown are the average results based on a series of laboratory tests of production units and are not necessarily representative of any one unit. Tests were run with the oil reservoir temperature at 120°F. Requests for more specific data should be directed to our sales representatives.

Performance data for pumps and motors having other gear widths can be approximated by multiplying values in tables below by actual gear width.

Pump Speed rpm	Avg. Output (gpm) @ 2000 psi Gear Width (inches)				
	1	1-1/2	2	2-1/2	3
600	6.0	11.5	16.5	21.0	26.0
1200	17.0	27.0	37.5	48.0	58.0
1500	22.0	35.5	48.0	61.0	74.0
2100	33.0	51.5	69.5	87.0	106.0

Motor Speed rpm	Avg. Input/Output (gpm) @ 2000 psi					
	1" gear		2" gear		2-1/2" gear	
	gpm	hp	gpm	hp	gpm	hp
800	20.5	18.0	35.5	36.5	43.0	46.5
1200	27.5	26.5	49.5	54.5	60.5	69.5
1600	34.0	35.0	64.0	72.0	78.5	91.5
2000	41.5	43.0	78.0	89.0	96.5	111.0

How To Specify and Code

This catalog contains codes for our most popular models. Complete codes for all configurations are readily available upon request.

Single Units

Full assembly codes for single units combine shaft end cover, port end cover, gear housing and drive shaft codes. They are preceded by the letter P or M for pump or motor — and by 76 to designate the series and model. An example of an assembly code follows:

M75 SINGLE MOTOR

Assembly Code: **M 76A 942 BE YF15-7**

- MotorM
- Series76
- ModelA
- 1. Shaft End Cover942
- 2. Port End CoverBE
- 3. Gear HousingYF15
- 4. Drive Shaft7

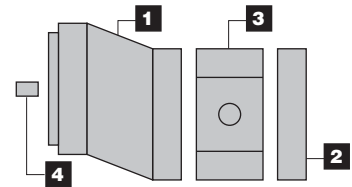

Multiple Units

Coding is the same as single units except that codes for added components must be included. Each gear unit added also requires code for a bearing carrier, the additional gear housing and connecting shaft. An example of an assembly code for a two-section Series 76 pump follows:

P76 MULTIPLE PUMP

Assembly Code: **P 76B 178 BI OK15-7 C OK12-1**

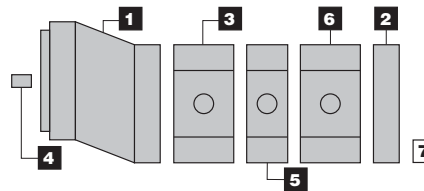

- PumpP
- Series76
- ModelB
- 1. Shaft End Cover178
- 2. Port End CoverBI
- 3. Gear HousingOK15
- 4. Drive Shaft7
- 5. Bearing CoverD
- 6. Gear HousingOK12
- 7. Connecting Shaft1

Variations

Series 76 units are available with gear sections ranging from 1/2" to 2-1/2" in 1/4" increments. Two or more gear sections can be assembled on one drive shaft to provide larger flows, supply other circuits or make smoother, more powerful motors.

When specifying multiple units you must consider the drive shaft's strength. This is called a PL factor in which P = operating pressure and L = sum of gear widths. The recommended PL factors for various Series 76 shafts are shown with the shaft codes and are offered as a guide to shaft selection. A PL of 8000 means a maximum of 4" of gear can be operated at 2000 psi (2000 psi X 4" = 8000) without overloading the shaft. The gear widths can be divided many ways, eg. (2"-1"-1", 1"-1"-1"-1", 1-1/2"-1-1/2"-1/2") to provide the output you need for several circuits.

P76 Parts Breakdown Typical Parts List

For Series P76 Seal Kits and Repair Parts, See Pages 475 - 477

Note:

This page shows the typical arrangement of a 2-section unit. It may not be pictorially correct and is not to scale.

Plug 7 in position B gives clockwise rotation.

Plug 7 in position A gives counter-clockwise rotation.

Check valves in both positions give bi-directional rotation.

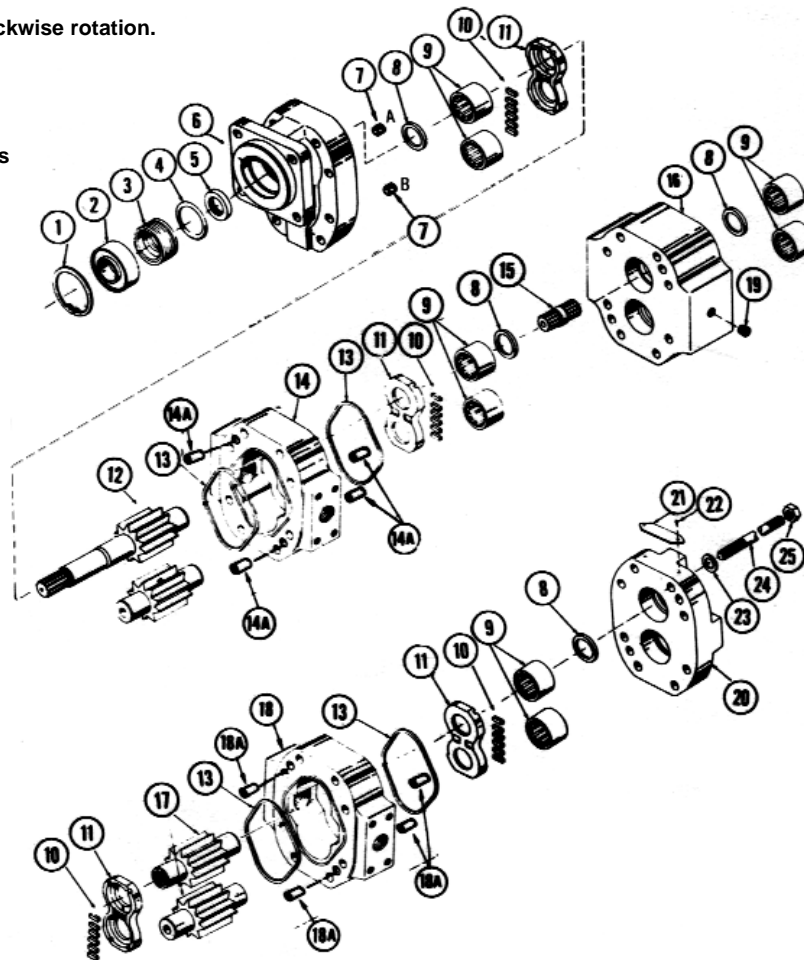

Item	Description	Part Number	Item	Description	Part Number
1	Snap Ring	CM-391-2686-025	13	Gasket Seals	
2	Outboard Bearing	CM-391-0381-078	14	Gear Housing	See Option List
	Spacer	CM-391-3383-018	14A	Dowel Pins	
3	Seal Retainer	CM-391-2584-051	15	Connecting Shaft	See Option List
4	"O" Ring	CM-391-2881-457	16	Bearing Carrier	See Option List
5	Seal (Pump)	CM-391-2883-052	17	Matched Gear Set	See Option List
	Seal (Motor)	CM-391-2883-094	18	Gear Housing	See Option List
6	Shaft End Cover		18A	Dowel Pins	
7	Check Assemblies	CM-391-3681-001	19	Plug	
	Plug	CM-391-2286-004	20	Port End Cover	
8	Ring Seals	CM-391-2585-011	21	Name Plate	
9	Roller Bearings	CM-391-0381-904	22	Drive Screws	
10	Pocket Seals	CM-391-2282-084	23	Washers	
11	Thrust Plates	CM-391-2185-920	24	Studs or Cap Screws	
12	Integral Drive Shaft and Gear Set	See Option List	25	Nuts	

1 & 2 Shaft & Port End Covers

P76 SHAFT END COVERS - PORT END COVERS

Description	Outboard Bearing	PUMPS		MOTORS	
		CW	CCW	1/4" NPT DRAIN	1/4" BSPP DRAIN
SAE D - 4 Bolt	Without	180	280	980	1980
	With	480	580	880	1880
SAE C - 2 Bolt	Without	198	298	998	1998
	With	498	598	898	1898
SAE B - 4 Bolt	Without	142	242	942	1942
	With	442	542	842	1842
SAE C - 4 Bolt	Without	178	278	978	1978
	With	478	578	878	1878

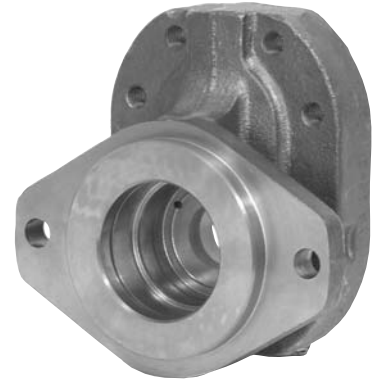

P76 PORT END COVERS

Description	Single Pumps	Multiple Pumps		Porting	
		w/Reg Studs	w/2 Ext Studs	LH	RH
No Port	BE	BI	BY	—	—
SAE Straight Thread Ports	JE	JI	JY	1	1
Metric Straight Thread Ports	TE	TI	TY	1	1
Piggyback Port End Cover	Type 75-50 75-30	CW KO	CCW LO	DUAL MO	



P76 GEAR & SHAFT COMBINATIONS

Shaft Description	Code	
	Type 1	Type 2
SAE C - 14 Tooth Spline - 1 5/16" Long For Single Units 1.2480" Major Dia.	7	—
SAE C - 14 Tooth Spline - 1 3/4" Spline For Multiple Units 1.248" Major Dia	7* (c)	—
SAE C - Straight (Shaft Only) For P75C Models. 1.250" Dia. 5/16 x 1 1/2" Key	11*	—
Connecting Shaft - Multiple Units	1	1
Connecting Shaft - Piggyback Pump	23	—

* Available for special application upon request. Not a stock item.

4 Drive Shafts

P76 DRIVE SHAFT CODE

Gear Width	1-23	7	7* (c)	11*
3/4	•	N/A	Same	•
1	•	•	as	•
1 1/4	•	•	Regular	•
1 1/2	•	•	Code 7	•
1 3/4	•	•		•
2	•	•		•
2 1/4	•	•		•
2 1/2	•	•		•
2 3/4	•	•		•
3	•	•		•

* Available for special application upon request. Not a stock item.



3 & 6 Gear Housings



P76 GEAR HOUSINGS - BSPP PORTS

Porting		3/4	1	1 1/4	1 1/2	1 3/4	2	2 1/4	2 1/2	2 3/4	3
LH	RH										
—	—	AB07	AB10	AB12	AB15	AB17	AB20	AB22	AB25	AB27	AB30
—	3/4	YQ07	YQ10	YQ12	YQ15						
3/4	1‡	YT07*‡	YT10‡								
1‡	3/4	YV07*‡	YV10‡	YV12	YV15		YV20	YV22			
1‡	—		SL10‡								
—	1				RQ12	RQ15		RQ20	RQ22	RQ25	
1	1				MP12*	MP15	MP17				
1	1 1/4‡				VY12‡*				VY22		
1 1/4‡	1				IX12‡*	IX15‡			IX22		
1 1/2‡	1					VI15‡		VI20‡			
—	1 1/4										UI25
1 1/4	1 1/4								PF22*	PF25	PF30
1 1/2‡	1 1/4							IS20‡*	IS22‡*		
3/4	3/4		YS10								
1 1/4	3/4										YW25

‡ Low pressure only.
* 2500 PSI maximum.

P76 GEAR HOUSINGS - OD TUBE PORTS

Porting		3/4	1	1 1/4	1 1/2	1 3/4	2	2 1/4	2 1/2	2 3/4	3
LH	RH										
—	—	AB07	AB10	AB12	AB15	AB17	AB20	AB22	AB25	AB27	AB30
3/4	1‡	EG07*‡									
1‡	3/4	EJ07*‡									
1	1				AF12*	AF15					
3/4	1 1/4‡		EH10‡								
1 1/4‡	3/4		EK10‡								
—	1			AD12*	AD15						
1	1 1/4‡			AG12*‡	AG15‡						
1	1 1/2‡			AH15‡							
1 1/4‡	1			AJ12*‡	AJ15‡						
1 1/2‡	1			AK15‡							
1	—			AC12*	AC15						

‡ Low pressure only.
*2500 PSI maximum.

P76 GEAR HOUSINGS - METRIC STRAIGHT THREAD PORTS

Porting		3/4	1	1 1/4	1 1/2	1 3/4	2	2 1/4	2 1/2	2 3/4	3
LH	RH										
—	—	AB07	AB10	AB12	AB15	AB17	AB20	AB22	AB25	AB27	AB30
3/4	1‡	ET07‡									
M26 X 1.5	M33 X 2										
1	3/4	EV07*‡			EV12	EV15					
M33 X 2	M26 X 1.5										
1	1				CM12*	CM15*					
M33 X 2	M33 X 2										
—	3/4‡	TQ07‡	TQ10	TQ12	TQ15						
—	M26 X 1.5										
—	1‡				ER12‡	ER15					
—	M33 X 2										

‡ Low pressure only,
* 2500 PSI maximum.

3 & 6 Gear Housings







P76 GEAR HOUSINGS - SAE SPLIT FLANGE PORTS

Porting		3/4	1	1 1/4	1 1/2	1 3/4	2	2 1/4	2 1/2	2 3/4	3
LH	RH										
—	—	AB07	AB10	AB12	AB15	AB17	AB20	AB22	AB25	AB27	AB30
3/4	1	UG07	UG10	UG12							
3/4	1 1/4				UH12						
—	1 1/4									OB25	
1	—	OC07*									
1	3/4	OJ07	UJ10								
1	1		OF10	OF12	OF15	OF17	OF20				
1	1 1/4‡		OG10‡	OG12							
1 1/4‡	1		OJ10‡	OJ12							
1 1/4	1 1/4			OL12*	OL15	OL17	OL20	OL22	OL25	OL274	OL30
1 1/2‡	1				OK12‡	OK15‡	OK17‡				
1	1 1/2‡				OH12‡	OH15‡	OH17‡				
1 1/4	1 1/2‡				OM12‡*	OM15‡	OM17‡	OM20	OM22		
1 1/2‡	1 1/4				OP12‡*	OP15‡	OP17‡	OP20	OP22		
1 1/2	1 1/2						OR20*	OR22	OR25	OR27	OR30
1 1/4	2‡					ON17‡	ON20‡	ON22‡	ON25‡	ON27	ON30
2‡	1 1/4					OQ17‡	OQ20‡	OQ22‡	OQ25‡	OQ27	OQ30
1 1/2	2‡						OS20‡*	OS22*	OS25‡	OS27	OS30
2‡	1 1/2						OV20‡*	OV22‡	OV25‡	OV27	OV30
2	2								OX25*	OX27*	OX30*
1 1/2	2 1/2‡								OT25‡	OT27‡	OT30‡
2 1/2	1 1/2								OW25‡	OW27‡	OW30‡
1 1/2‡	—				OE12‡			OE20*	OE22		
—	1 1/2							OU20*	OU22		

‡ Low pressure only.
* 2500 PSI maximum.







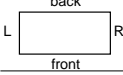

5 Bearing Carriers

P76 BEARING CARRIERS

	LH	RH	NPT Code	SAE Split Flange Code	ODT Code	BSPP Code	METRIC Split Flange Code	Str Thread Code
MOTORS								
	—	—	B			B		
	1 1 1/4 1 1/2	1 1 1/4 1 1/2	— — —	LL MM NN	CC BB —	EE GG HH	RR SS XX	KK JJ ZZ
PUMPS								
	—	—	C			C		
	—	—	A D U			A D U		



P76 FLOW DIVIDERS ONLY

	Ports		NPT Code	SAE Split Flange Code	ODT Code	BSPP Code	METRIC Split Flange Code	Str. Thread Code
	LH	RH						
	—	—	E			E		
	1 1 1/4 1 1/2	— — —		J K L	F G H	X Y Z	T V W	Q R S
	— 1 1 1/4 1 1/2	3/4 3/4 3/4 3/4		GR HR PR QR	GJ HJ MJ RJ	DG FG SG XG	TR VR WR XR	QJ SJ XJ ZJ
	— 1 1 1/4 1 1/2	1 1 1 1		MT NT RT	BK PK RK	DF GF MF	FM QM VM	ML PL QL
	— 1 1 1/4 1 1/2	3/4 3/4 3/4 3/4		FD GD MD PD	JH PH RH WH	DM NM PM TM	KT PT QT ZT	BZ PZ QZ YZ
	— 1 1 1/4 1 1/2	1 1 1 1		JG PG RG	PC QC VC	MN QN TN	RP PT ZP	MK QK SK
	1	3/4		WL	MC	HP	FP	CP
	1	3/4		ZL	SC	LP	GP	DP



330 350 365

General Information

Model 330, 350 and 365 pumps and motors are external spur gear, fixed displacement units designed for continuous operation at pressures up to 3500 psi. They combine a practical high pressure capability with the economy and durability of gear equipment.

High Efficiency

Advances in thrust plate designs and seal material contribute to pump volumetric efficiency as high as 95% of theoretical, even with fluid viscosity as low as 50 SUS. Longer gear journals present a large effective area to the sleeve bearings and provide excellent load distribution. Internal passages supply a constant flow of lubrication from the pump's inlet to all bearing surfaces. This ensures a film of clean, cool oil on all moving parts at all times. These features greatly extend service life.

Heavy-duty Construction

Housings are made from cast iron for durability and strength. Units are available in single and multiple assemblies.

The drive gears and shafts are machined from a one-piece forging to provide maximum strength. Gear teeth and journals are carburized and ground to a precision finish.

Cast-bronze thrust plates are pressure loaded and are designed to provide minimum clearance at the ends of the gears for outstanding efficiency.

Mountings

Standard SAE B 2- and 4- bolt (ANSI 101-2, 101-4) and SAE C 2- and 4- (ANSI 127-2, 127-4) flange mountings are available. Shaft end covers can have a single or twin shaft seal. A tapped drain hole is provided when twin seals are specified.

Rotation

Pumps can be assembled for either CCW or CW rotation. Motors are bi-directional.

Drives

Direct drives are recommended. Radial loads are permissible with an optional outboard bearing but are subject to approval by Commercial. Contact our sales representatives for details.

Optional Assemblies

For those applications where it is necessary to provide a braking effect to the drive unit, we offer built-in crossover relief protection. These motors save plumbing and simplify installations.

Performance Data

Performance data shown are the average results based on a series of laboratory tests of production units and are not necessarily representative of any one unit. Tests were run with the oil reservoir temperature at 120°F. Requests for more specific data should be directed to our sales representatives.

Performance data for pumps and motors having other gear widths can be approximated by multiplying values in tables below by actual gear width.

330 Pump Speed rpm	Avg. Output (gpm) @ 3500 psi Gear Width (inches)				
	1	1-1/4	1-1/2	1-3/4	2
900	6.0	8.0	10.0	12.0	13.5
1200	8.5	11.5	14.0	16.0	18.5
1500	11.0	14.5	17.5	20.5	23.5
2100	16.5	21.0	25.0	29.5	34.0

2" data at 3000 psi

Motor Speed rpm	Avg. Input/Output (gpm) @ 3500 psi					
	1" gear		1-1/2" gear		2" gear	
	gpm	in-lbs	gpm	in-lbs	gpm	in-lbs
900	9.5	995	13.5	1495	17.5	1720
1200	12.5	995	17.5	1500	22.5	1725
1500	15.0	985	21.5	1495	28.0	1720
2100	20.0	925	29.5	1440	38.5	1670

2" data at 3000 psi

Pump Speed rpm	Avg. Output (gpm) @ 3500 psi Gear Width (inches)						
	1	1-1/4	1-1/2	1-3/4	2	2-1/4	2-1/2
900	8.0	10.5	13.0	15.0	17.5	20.0	22.0
1200	11.5	15.0	18.0	21.0	24.0	27.0	30.0
1500	14.5	19.0	23.0	27.0	31.0	35.0	39.0
2100	21.0	27.0	32.5	38.5	44.0	49.5	55.0

2-1/2" data at 2500 psi
2" data at 3000 psi

350 Motor Speed rpm	Avg. Input/Output (gpm) @ 3500 psi							
	1" gear		1-1/2" gear		2" gear		2-1/2" gear	
	gpm	in-lbs	gpm	in-lbs	gpm	in-lbs	gpm	in-lbs
900	13.5	1240	18.5	1950	23.5	2260	28.5	2360
1200	17.0	1250	23.5	1960	30.0	2260	37.0	2360
1500	20.0	1240	28.5	1960	36.5	2230	45.0	2330
2100	26.5	1175	38.5	1840	50.0	2100	62.0	2180

2-1/2" data at 2500 psi
2" data at 3000 psi

Pump Speed rpm	Avg. Output (gpm) @ 3500 psi Gear Width (inches)						
	1	1-1/4	1-1/2	1-3/4	2	2-1/4	2-1/2
900	10.5	13.5	15.0	17.0	20.5	27.5	31.0
1200	15.5	20.0	24.5	29.0	33.5	38.0	43.0
1500	20.0	25.5	31.0	37.5	43.0	49.0	55.0
2100	29.0	37.5	45.5	54.0	62.0	70.0	78.0

2-1/2" data at 3000 psi

365 Motor Speed rpm	Avg. Input/Output (gpm) @ 3500 psi							
	1" gear		1-1/2" gear		2" gear		2-1/2" gear	
	gpm	in-lbs	gpm	in-lbs	gpm	in-lbs	gpm	in-lbs
900	18.4	1865	25.6	2860	32.9	3850	40.1	4125
1200	23.3	1845	32.9	2830	42.4	3810	52.0	4080
1500	28.2	1815	40.1	2780	52.0	3750	63.8	4020
2100	37.9	1755	54.4	2690	71.1	3610	87.6	3865

2-1/2" data at 3000 psi

P330 Parts Breakdown Typical Parts List

For Series P330 Seal Kits and Repair Parts, See Pages 475 - 477

Note:

Plug 5 required in position A and B.

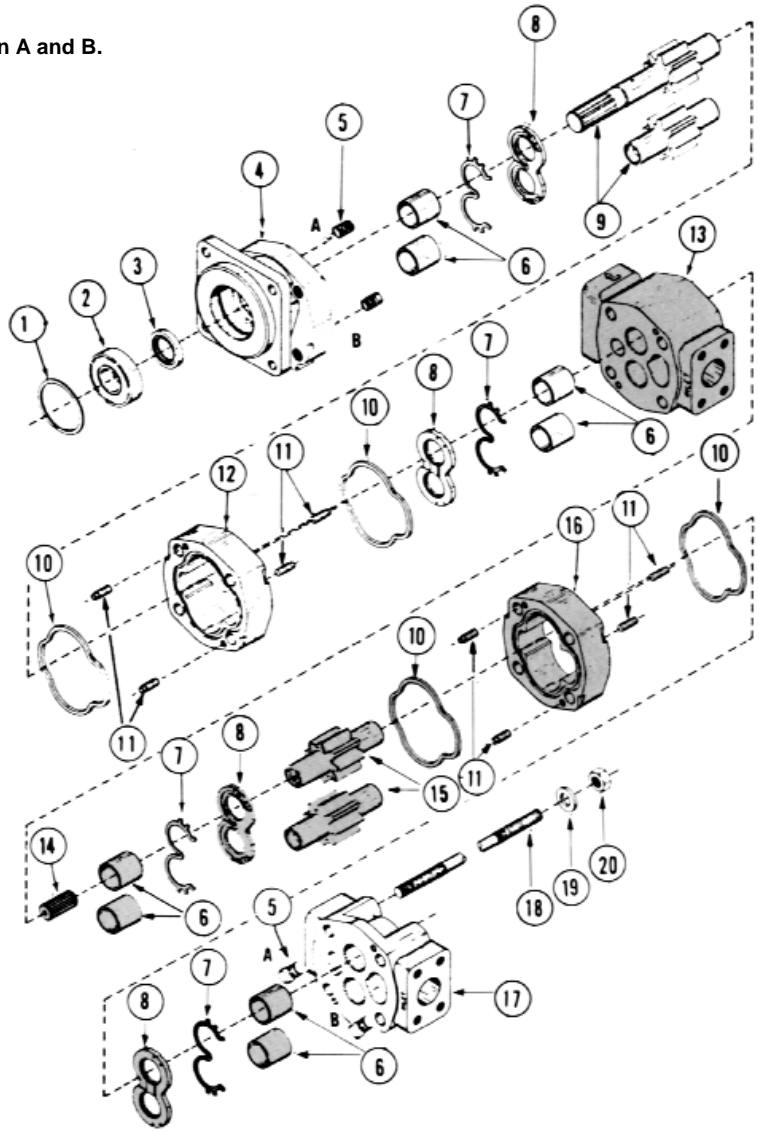

Item	Description	Part Number	Item	Description	Part Number
1	Snap Ring	300-206	10	Gasket Seal	580-242
2	Outboard Bearing	CM-391-0381-040	11	Dowel Pins (Solid)	CM-391-2082-032
3	Seal	CM-391-2883-058	12	Gear Housing	See Option List
4	Shaft End Cover	See Option List	13	Bearing Carrier	See Option List
5	Plug		14	Connection Shaft	See Option List
6	Bushings	CM-391-0482-306	15	Matched Gear Set	See Option List
7	Channel Seal	CM-391-2885-065	16	Gear Housing	See Option List
8	Thrust Plates	CM-391-2185-956	17	Port End Cover	
9	Integral Drive Shaft and Gear Set		18	Studs or Cap Screws	
			19	Washers	
			20	Nuts	

For Series P350 Seal Kits and Repair Parts, See Pages 475 - 477

P350 Parts Breakdown Typical Parts List

Note:

Plug 5 in position B gives clockwise rotation.

Plug 5 in position A gives counter-clockwise rotation.

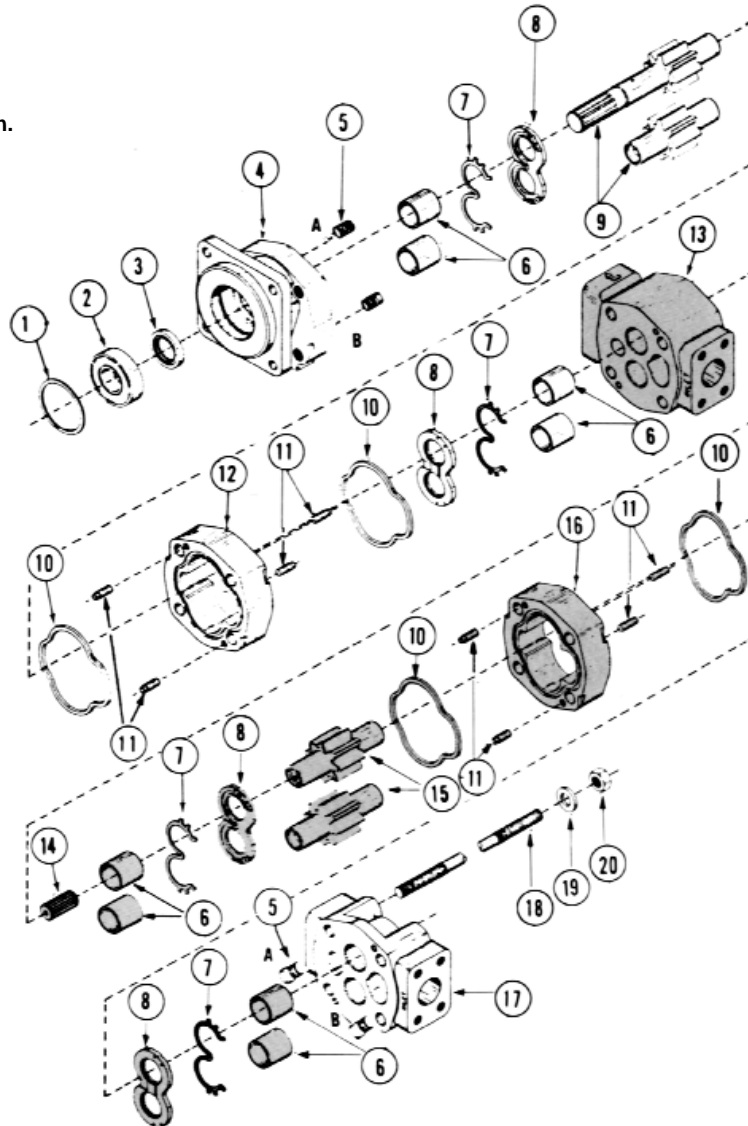

Item	Description	Part Number	Item	Description	Part Number
1	Snap Ring	WHM-283	10	Gasket Seal	580-246
2	Outboard Bearing	CM-391-0381-077	11	Dowel Pins (Solid)	CM-391-2082-032
3	Seal	CM-391-2883-103	12	Gear Housing	See Option List
4	Shaft End Cover	See Option List	13	Bearing Carrier	See Option List
5	Plug		14	Connection Shaft	See Option List
6	Bushings	CM-391-0482-308	15	Matched Gear Set	See Option List
7	Channel Seal	CM-391-2885-066	16	Gear Housing	See Option List
8	Thrust Plates	CM-391-2185-957	17	Port End Cover	
9	Integral Drive Shaft and Gear Set		18	Studs or Cap Screws	
			19	Washers	
			20	Nuts	

P365 Parts Breakdown Typical Parts List

For Series P365 Seal Kits and Repair Parts, See Pages 475 - 477

Note:

Plug 5 in position B gives clockwise rotation.

Plug 5 in position A gives counter-clockwise rotation.

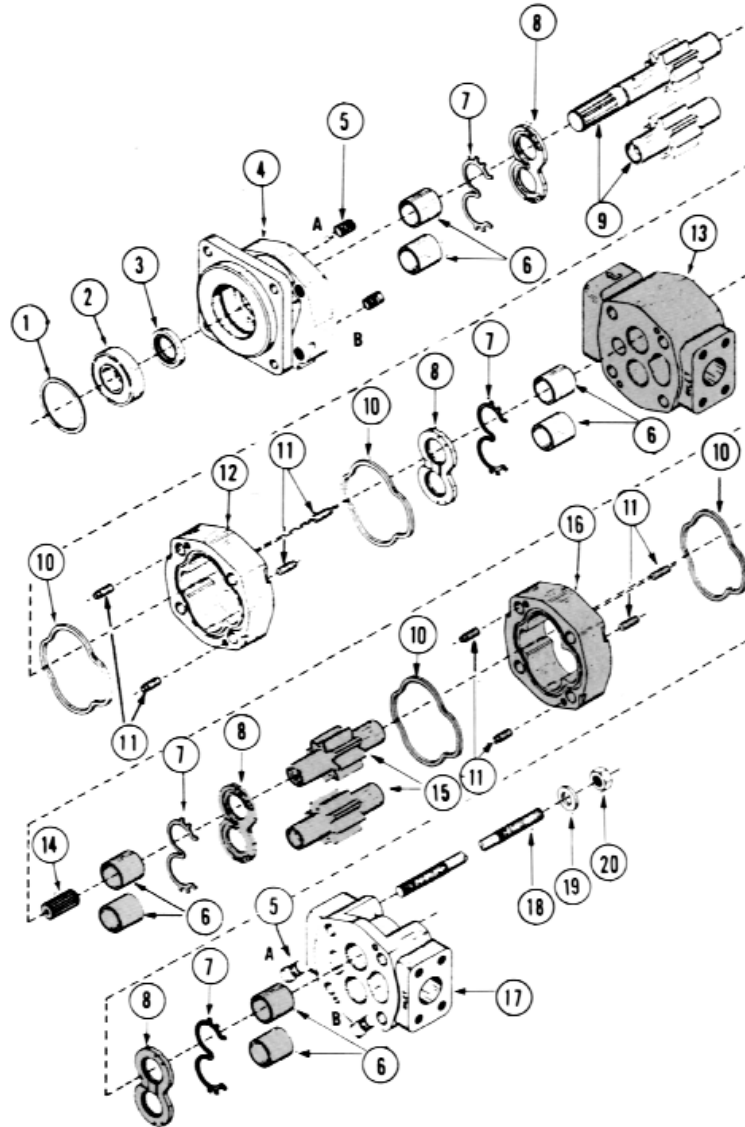

Item	Description	Part Number	Item	Description	Part Number
1	Snap Ring	300-315	10	Gasket Seal	580-250
2	Outboard Bearing	CM-391-0381-078	11	Dowel Pins (Hollow)	CM-391-2082-062
3	Seal	CM-391-2883-052	12	Gear Housing	See Option List
4	Shaft End Cover	See Option List	13	Bearing Carrier	See Option List
5	Plug		14	Connection Shaft	See Option List
6	Bushings	CM-391-0482-307	15	Matched Gear Set	See Option List
7	Channel Seal	CM-391-2885-064	16	Gear Housing	See Option List
8	Thrust Plates	CM-391-2185-955	17	Port End Cover	
9	Integral Drive Shaft and Gear Set		18	Studs or Cap Screws	
			19	Washers	
			20	Nuts	

1 & 2 Shaft & Port End Covers

P330/350/365 SHAFT END COVERS

Description	PUMPS				MOTORS	
	Type	Outboard Bearing	CW	CCW	1/4" NPT DRAIN	1/4" BSPP DRAIN
SAE B 4 Bolt	1	Without	142	242	942	—
		With	442	542	842	—
SAE C 4 Bolt	1	Without	178	278	978	1978
		With	478	578	878	—
SAE B 2 Bolt P330/P350 Only	1	Without	197	297	997	—
		With	497	597	897	—
SAE C 2 Bolt P350/P365 Only	1	Without	198	298	998	—
		With	498	598	—	—



P330/350/365 PORT END COVERS Side Ported

Porting		Split Flange Ports Pump			ODT Ports Pump		
Inlet	Outlet	CW	CCW	Motor Double	CW	CCW	Motor Double
—	—	BI	IB (BI-P330)	BA	—	—	—
2	1 1/2	EC*	CE*	—	—	—	—
2	1 1/4	EF*	FE*	—	—	—	—
2	1	EG*	GE*	—	—	—	—
1 1/2	1 1/2	EH*	HE*	CR*	—	—	—
1 1/2	1 1/4	EJ	JE	—	FB*	BF*	—
1 1/2	1	EK	KE	—	FC*	CF*	—
1 1/4	1 1/4	EL	LE	CS	FG*	GF*	VC
1 1/4	1	EM	ME	—	FJ	JF	—
1	1	EN	NE	CT	FL	LF	VN
2	—	OE*	EO*	—	—	—	—
1 1/2	—	OF	FO	—	BC*	CB*	—
1 1/4	—	OG	GO	—	BG	GB	—
1	—	OJ	JO	—	BJ	JB	—
—	1 1/2	OL*	LO*	—	—	—	—
—	1 1/4	OM	MO	—	BL	LB	—
—	1	ON	NO	—	BN	NB	—
3/4	3/4	—	—	CV	—	—	VR

330



350



365



* Not available on 330. All other codes good for 330/350/365.

P330/350/365 METRIC PORT END COVERS Side Ported

Porting		Metric Split Flange Pump		Metric Str. Thd.		BSPP Pump		Motor Double
Inlet	Outlet	CW	CCW	Motor Double	Motor Double	CW	CCW	Motor Double
2	1 1/2	ER*	RE*	—	—	—	—	—
2	1 1/4	ES*	SE*	—	—	—	—	—
2	1	ET*	TE*	—	—	—	—	—
1 1/2	1 1/2	EU*	UE	CW*	—	—	—	—
1 1/2	1 1/4	EV	VE	—	—	FN	NF	—
1 1/2	1	EW	WE	—	—	FP	PF	—
1 1/4	1 1/4	EX	XE	CX	VS	FR	RF	VX
1 1/4	1	EY	YE	—	—	FS	SF	—
1	1	EZ	ZE	CV	VT	FT	TF	VY
2	—	OP*	PO*	—	—	—	—	—
1 1/2	—	OR	RO	—	—	BP	PB	—
1 1/4	—	OS	SO	—	—	BQ	QB	—
1	—	OT	TO	—	—	BR	RB	—
—	1 1/2	OV*	VO*	—	—	—	—	—
—	1 1/4	OE	WO	—	—	BT	TB	—
—	1	OX	XO	—	—	BU	UB	—
3/4	3/4	—	—	CZ	VW	—	—	VZ

* Not available on 330. All other codes good for 330/350/365.

3 & 6 Gear Housings



P330/350/365 GEAR HOUSINGS

Gear housings are not ported on the 330, 350 and 365 models.

	Code	330	350	365
Pumps	AB	05 thru 20	05 thru 25	07 thru 25
Motors	EB	05 thru 20	10 thru 25	10 thru 27

4 Drive Shafts



P330/350/365 DRIVE SHAFTS

Description	330	Code	350	Code	365	Code
Connecting Shaft		05-1 07-1 10-1 12-1 15-1 17-1 20-1		05-1 07-1 10-1 12-1 15-1 17-1 20-1 22-1 25-1		— 07-1 10-1 12-1 15-1 17-1 20-1 22-1 25-1
SAE C-14 teeth involute spline		07-7 10-7		10-7 12-7		07-7 10-7
ANSI 32-4 Major dia. 1.228 1.223 Minor dia. 1.0627 max. (1.040 max - 365)	— — Continental ‡	12-7 15-7 17-7 20-7	Single Tandem —	15-7 17-7 20-7 22-7 25-7	Single Tandem —	12-7 15-7 17-7 20-7 22-7 25-7
SAE C-14 Keyed ANSI 32-1 diameter 1.250 Key (.31 x .31 1.50)	— — —		— — Continental ‡	10-11 12-11 15-11 17-11 20-11 22-11 25-11	— — Continental ‡	07-11 10-11 12-11 15-11 17-11 20-11 22-11 25-11
SAE B-13 teeth involute spline ANSI 22-4 Major dia. .858 .853 Minor dia. .7335 max.	Single Tandem —	07-25 10-25 12-25 15-25 17-25 20-25	Single Tandem —	07-25 10-25 12-25 15-25 17-25 20-25 22-25 25-25		
SAE B-Keyed ANSI 22-1 diameter .875 Key (.25 x .25 x 1.00)		07-30 10-30 12-30 15-30 17-30 20-30				
SAE BB Keyed ANSI 25-1 diameter 1.000 Key (.25 x .25 x 1.25)	Single Tandem Continental ‡	07-43 10-43 12-43 15-43 17-43 20-43				
SAE BB-15 teeth involute spline ANSI 25-4 Major dia. .983 .978 Minor dia. .840	Single Tandem	10-98 12-98 15-98 17-98 20-98				

‡ Continental shafts require shaft end covers with outboard bearings.



5 Bearing Carriers

P330/350/365 BEARING CARRIER CODES

					PUMP CODES				MOTOR CODES	
	Inlet	Outlet		Clockwise Code		Counterclockwise Code		Double		
		Top	Bottom	Split Flange	ODT	Split Flange	ODT	Split Flange	ODT	
Dual Outlet	2 1/2*	1 1/2	1 1/2	AC	—	CA*	—	—	—	
	2 1/2	1 1/2	1 1/4	AD*	—	DA*	—	—	—	
	2 1/2	1 1/2	1	AE*	—	EA*	—	—	—	
	2 1/2	1 1/4	1 1/4	AF*	—	FA*	—	—	—	
	2 1/2	1 1/4	1	AG*	—	GA*	—	—	—	
	2 1/2	1	1	AH*	—	HA*	—	—	—	
	2	1 1/2	1 1/2	AJ*	GJ*	JA*	JG*	—	—	
	2	1 1/2	1 1/4	AK*	GK*	KA*	KG*	—	—	
	2	1 1/2	1	AL*	GL*	LA*	LG*	—	—	
	2	1 1/4	1/14	AM	GM ‡	MA	MG ‡	—	—	
	2	1 1/4	1	AN	GN ‡	NA	NG ‡	—	—	
	2	1	1	AP	GP ‡	PA	PG ‡	—	—	
	1 1/2*	1 1/2	1 1/2	AQ*	GQ*	QA*	QG*	—	—	
	1 1/2*	1 1/2	1 1/4	AR*	GR*	RA*	RG*	—	—	
	1 1/2*	1 1/2	1	AS*	GS*	SA*	SG*	—	—	
	1 1/2	1 1/4	1 1/4	AT	GT ‡	TA	TG ‡	—	—	
	1 1/2	1 1/4	1	AU	GU ‡	UA	UG ‡	—	—	
	1 1/2	1	1	AV	GV	VA	VG	—	—	
	1 1/4	1 1/4	1 1/4	AW	GW ‡	WA	WG ‡	—	—	
	1 1/4	1 1/4	1	AX	GX ‡	XA	XG ‡	—	—	
1 1/4	1	1	AY ‡	GY	YA ‡	YG	—	—		
1	1	1	AZ	GZ	ZA	ZG	—	—		
Single Outlet	Inlet	Outlet								
	2 1/2*	1 1/2	—	CJ*	—	JC*	—	—	—	
	2 1/2*	1 1/4	—	CL*	—	LC*	—	—	—	
	2 1/2*	1	—	CM*	—	MC*	—	—	—	
	2	1 1/2	—	HB	KB ‡	BH	BK ‡	—	—	
	2	1 1/4	—	HC	KC ‡	CH	CK ‡	—	—	
	2	1	—	HF	KF ‡	FH	FK ‡	—	—	
	1 1/2	1 1/2	—	HL	KL ‡	LH	LK ‡	—	—	
	1 1/2	1 1/4	—	HM	KM	MH	MK	—	—	
	1 1/2	1	—	HN	KN	NH	NK	—	—	
	1 1/4	1 1/4	—	HO	KO	OH	OK	—	—	
1 1/4	1	—	HP	KP	PH	PK	—	—		
1	1	—	HQ	KQ	QH	QK	—	—		
Com-bined Outlet	2 1/2*	1 1/2	—	UC*	—	CU*	—	—	—	
	2 1/2*	1 1/4	—	UF*	—	FU*	—	—	—	
	2	2	—	—	—	—	—	AA ‡	—	
	2	1 1/2	—	UN	PE ‡	NU	EP ‡	—	—	
	2	1 1/4	—	UO	PM ‡	OU	MP ‡	—	—	
	1 1/2	1 1/2	—	UP	PN ‡	PU	NP ‡	BB	MM ‡	
	1 1/2	1 1/4	—	UQ	PQ	QU	QP	—	—	
	1 1/4	1 1/4	—	UR	PR	RU	RP	CC	NN	
1	1	—	—	—	—	—	EE	QQ		
3/4	3/4	—	—	—	—	—	FF	RR		
Com-bined Outlet	—	—	—	C	—	D	—	—		

‡ Not available on P330

* Available on P365 only

5 Bearing Carriers



P330/350/365 BEARING CARRIER CODES

	Inlet	Outlet		PUMP CODES				MOTOR CODES		
		Top	Bottom	Clockwise		Counterclockwise		Metric Split Flange	Double	
				Metric Split Flange	BSPP	Metric Split Flange	BSPP		Metric Split Flange	ODT
Dual Outlet	2 1/2	1 1/2	1 1/2	DB*	—	BD*	—	—	—	—
	2 1/2	1 1/2	1 1/4	DC*	—	CD*	—	—	—	—
	2 1/2	1 1/2	1	DE*	—	ED*	—	—	—	—
	2 1/2	1 1/4	1 1/4	DF*	—	FD*	—	—	—	—
	2 1/2	1 1/4	1	DG*	—	GD*	—	—	—	—
	2 1/2	1	1	DH*	—	HD*	—	—	—	—
	2	1 1/2	1 1/2	DJ*	JH	JD*	HJ	—	—	—
	2	1 1/2	1 1/4	DK*	JK	KD*	KJ	—	—	—
	2	1 1/2	1	DL*	JL	LD*	LJ	—	—	—
	2	1 1/4	1/14	DM	JM	MD	MJ	—	—	—
	2	1 1/4	1	DN	JN	ND	NJ	—	—	—
	2	1	1	DP	JP	PD	PJ	—	—	—
	1 1/2	1 1/2	1 1/2	DQ*	JQ	QD*	QJ	—	—	—
	1 1/2	1 1/2	1 1/4	DR*	JR	RD*	RJ	—	—	—
	1 1/2	1 1/2	1	DS*	JS	SD*	SJ	—	—	—
	1 1/2	1 1/4	1 1/4	DT	JT	TD	TJ	—	—	—
	1 1/2	1 1/4	1	DU	JU	UD	UJ	—	—	—
	1 1/2	1	1	DV	JV	VD	VJ	—	—	—
	1 1/4	1 1/4	1 1/4	DW	JW	WD	WJ	—	—	—
	1 1/4	1 1/4	1	DX	JX	XD	XJ	—	—	—
1 1/4	1	1	DY ‡	JY	YD ‡	YJ	—	—	—	
1	1	1	DZ	JZ	ZD	ZJ	—	—	—	
Single Outlet	Inlet	Outlet								
	2 1/2	1 1/2	—	CN*	—	NC	—	—	—	—
	2 1/2	1 1/4	—	CP*	—	PC	—	—	—	—
	2 1/2	1	—	CQ*	—	QC	—	—	—	—
	2	1 1/2	—	HR*	—	RH	—	—	—	—
	2	1 1/4	—	HS*	—	SH	—	—	—	—
	2	1	—	HT*	—	TH	—	—	—	—
	1 1/2	1 1/2	—	HU*	—	UH	—	—	—	—
	1 1/2	1 1/4	—	HV*	—	VH	—	—	—	—
	1 1/2	1	—	HW*	—	WH	—	—	—	—
	1 1/4	1 1/4	—	HX*	—	XH	—	—	—	—
	1 1/4	1	—	HY*	—	YH	—	—	—	—
	1	1	—	HZ*	—	ZH	—	—	—	—
Com-bined Outlet	2	2	—	—	—	—	—	GG ‡	—	—
	1 1/2	1 1/2	—	—	—	—	—	HH	WW ‡	SS ‡
	1 1/4	1 1/4	—	—	—	—	—	JJ	XX	TT
	1	1	—	—	—	—	—	KK	YY	UU
	3/4	3/4	—	—	—	—	—	LL	ZZ	VV

‡ Not available on P330
 * Available on P365 only